

# Infanterie-opstellingen in Permanente Werken.

Bestaande Voorstellen (1:100.)

Fig: 1. volgens Voorduin (1887.)

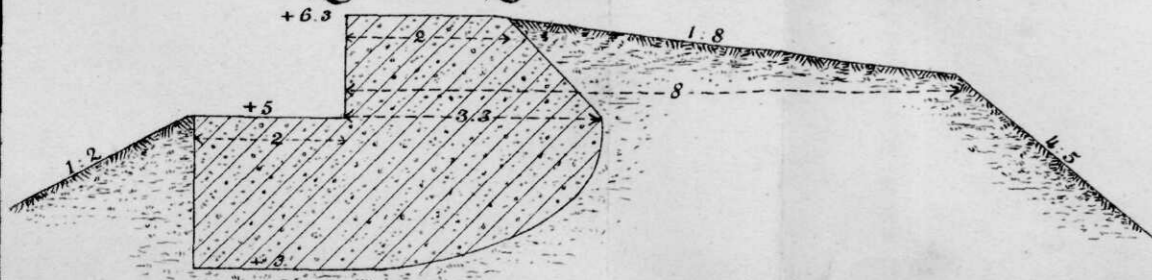

Fig 2. volgens Snijders (1891)

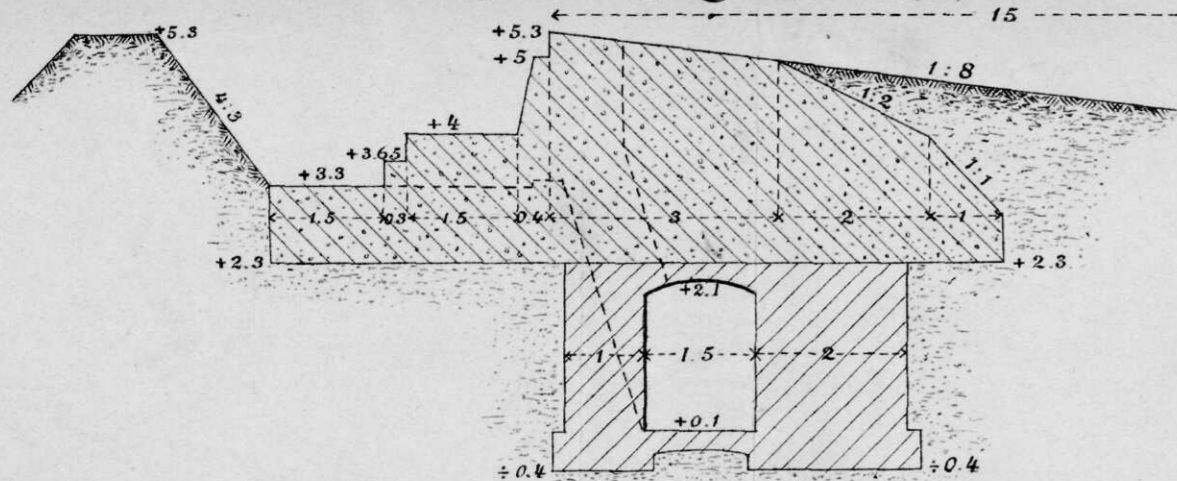

Fig: 3. volgens von Leithner (1894)

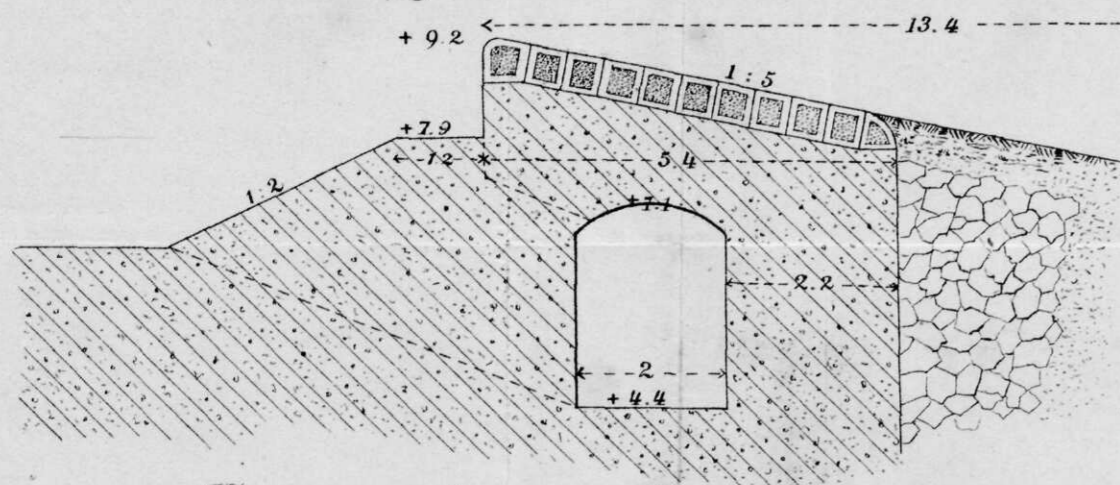
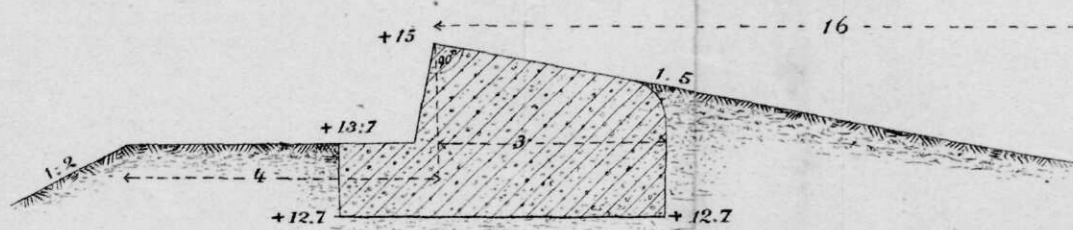

Fig: 4. volgens Deguise (1896.)



Opstelling met Schilden (1:50.)

Fig: 5. Profiel volgens C.O.

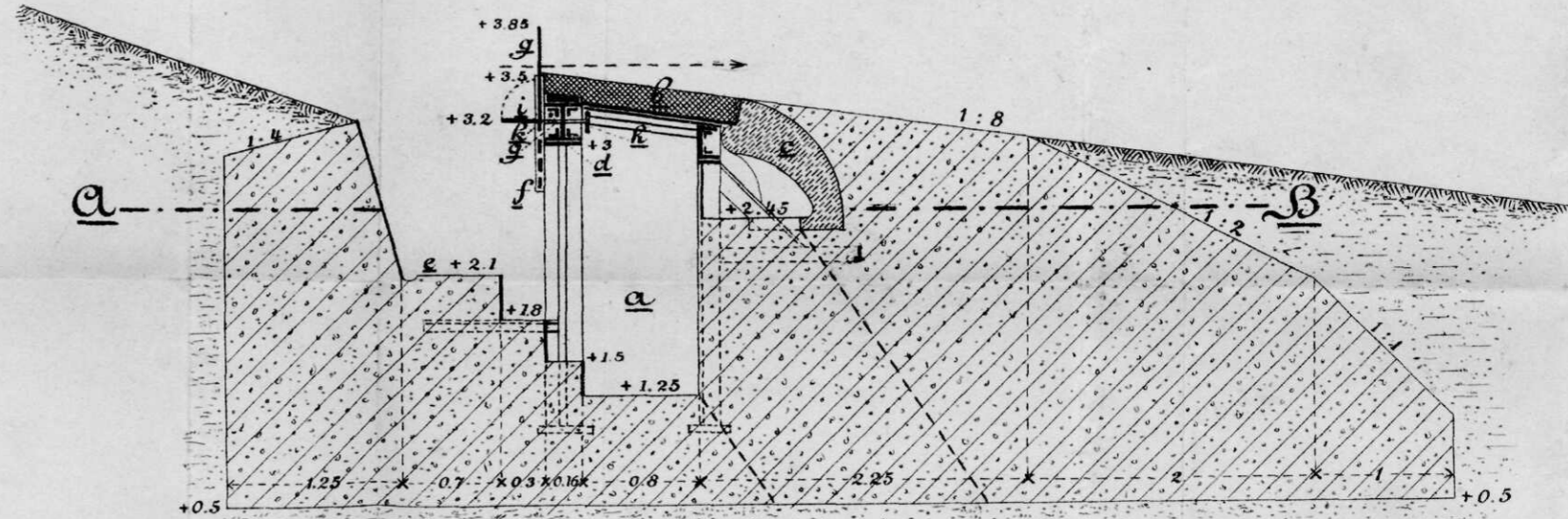

Fig: 6. Platte Grond volgens A.B.

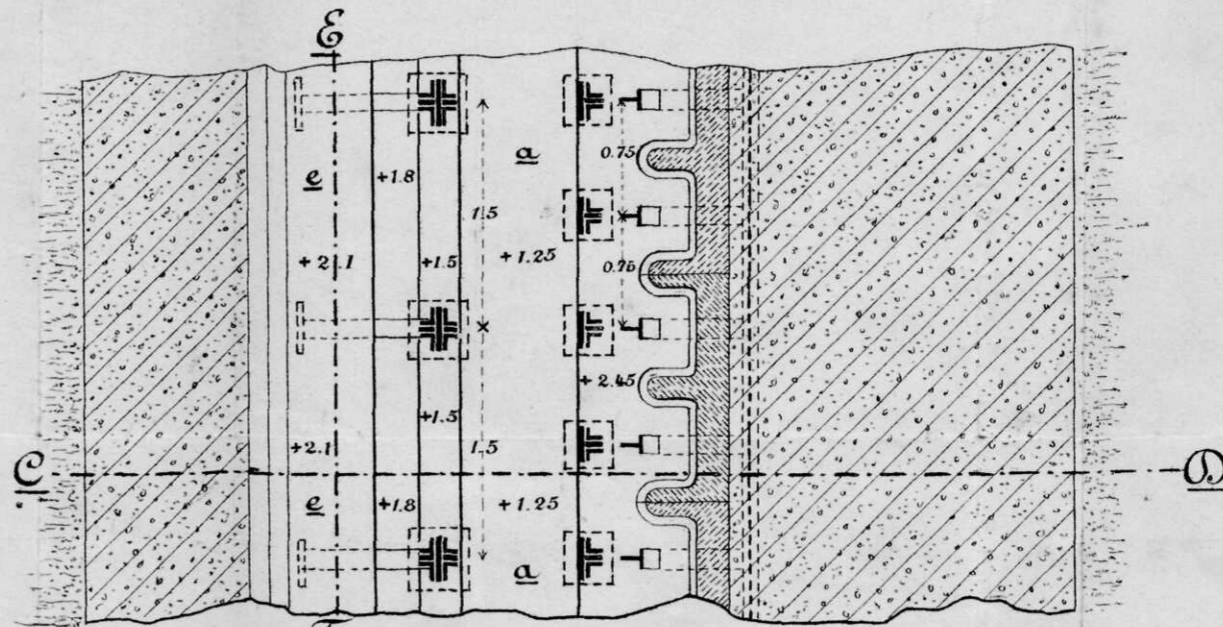
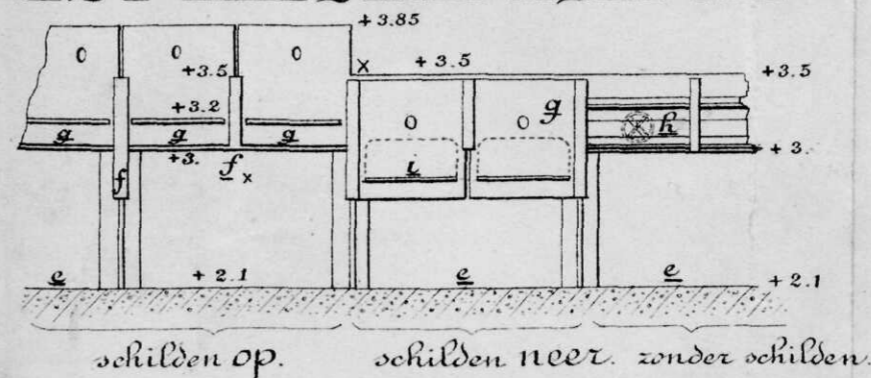

Fig: 7. Standgezicht volgens E.F.



leg

# Ontwerp van een Fort

## op een breed acces in eene Inundatie

Fig: 3 Doorsnede volgens C.D (1:200)

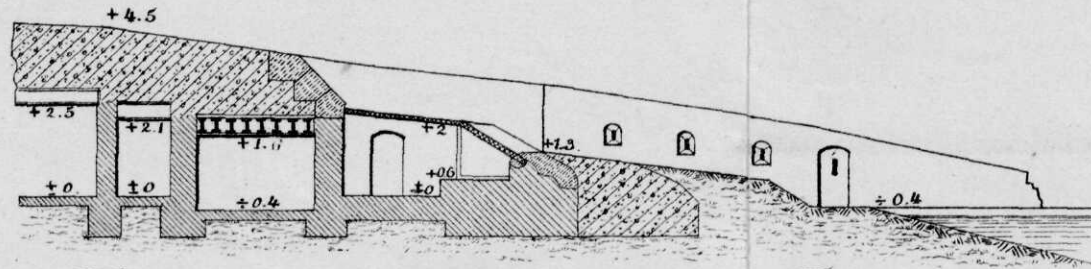

Fig: 4 Doorsnede volgens E.F. (1:200)

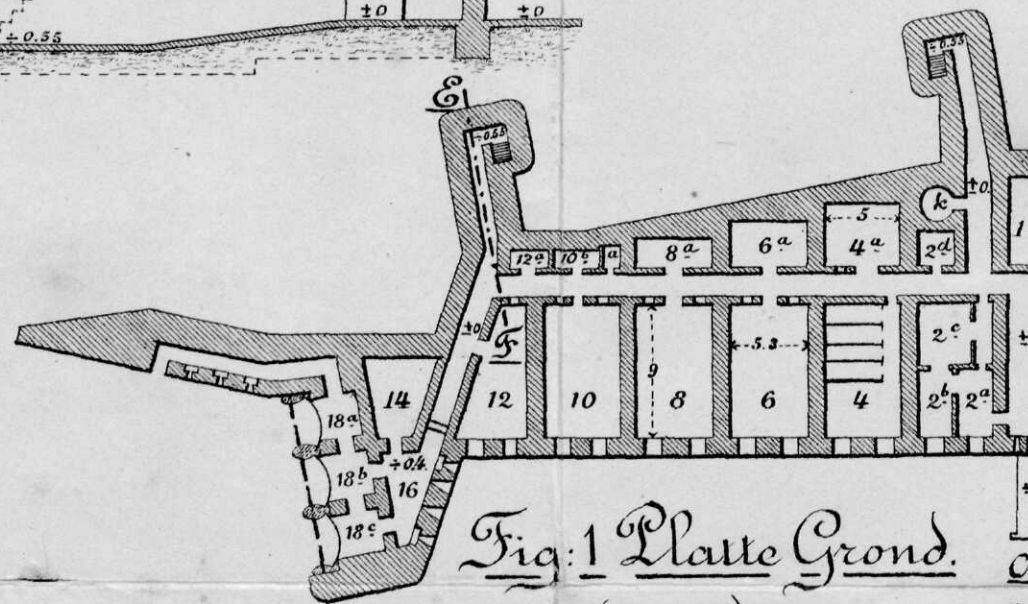
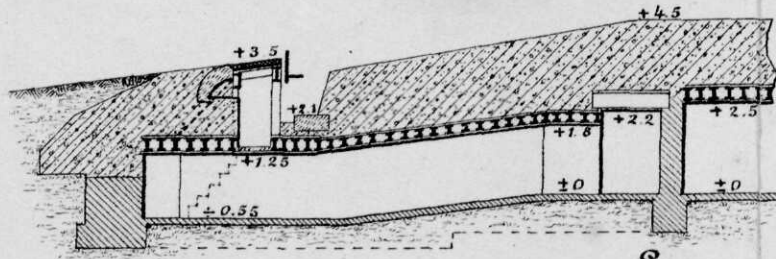

Fig: 1 Platte Grond.  
(1:500.)

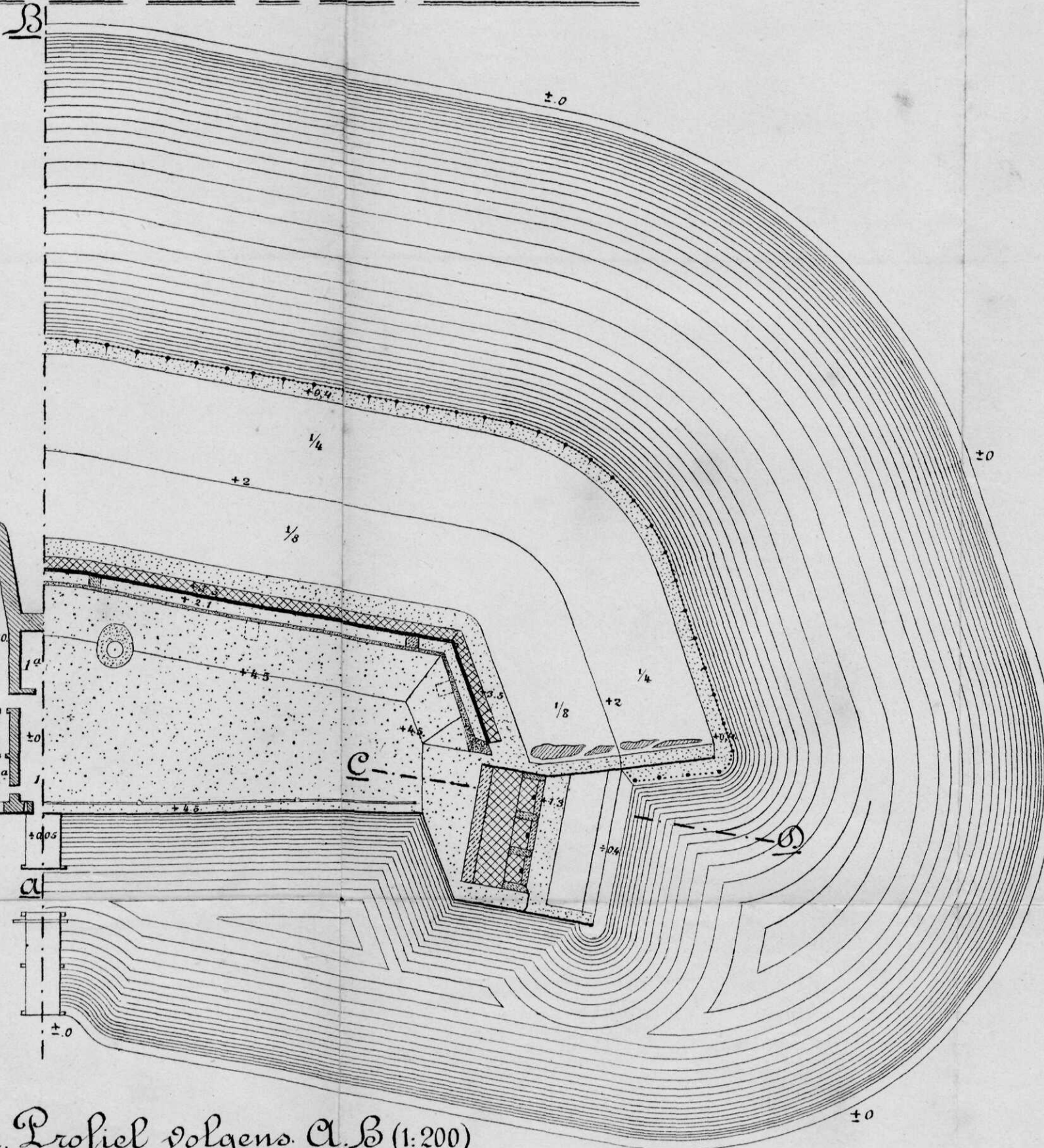
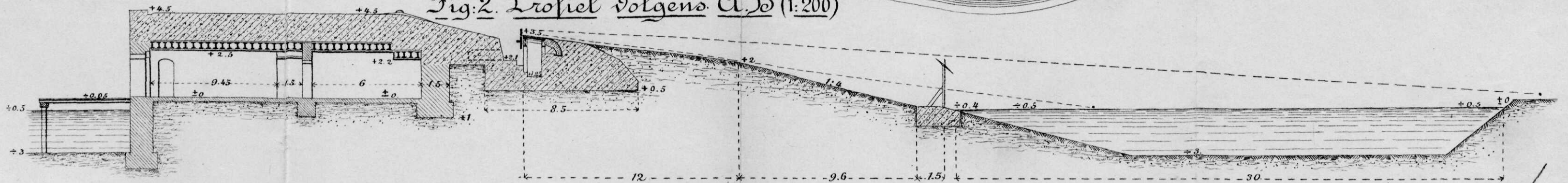

Fig: 2 Profiel volgens A.B (1:200)



### Doelichtingen

- Terrainpeil..... ±0
- Inundatiewaterstand... ±0,5M
- Normale waterstand... ±1,4M

### Bezetting

- 1. Comp<sup>ie</sup> Infanterie,
- 1. Det<sup>mt</sup> Voet<sup>ing</sup>-artillerie,  
(48 Hoofden)
- 2. Geniesoldaten-telegrafist,
- 1. Officier van Gezondheid,
- 2. Hospitaalsoldaten.

### Bewapening

- 6 snelv. kanonnen van 7.5cM.
- 2. id. id. id. 5,7. „
- 6. mitrailleurs.

Mg

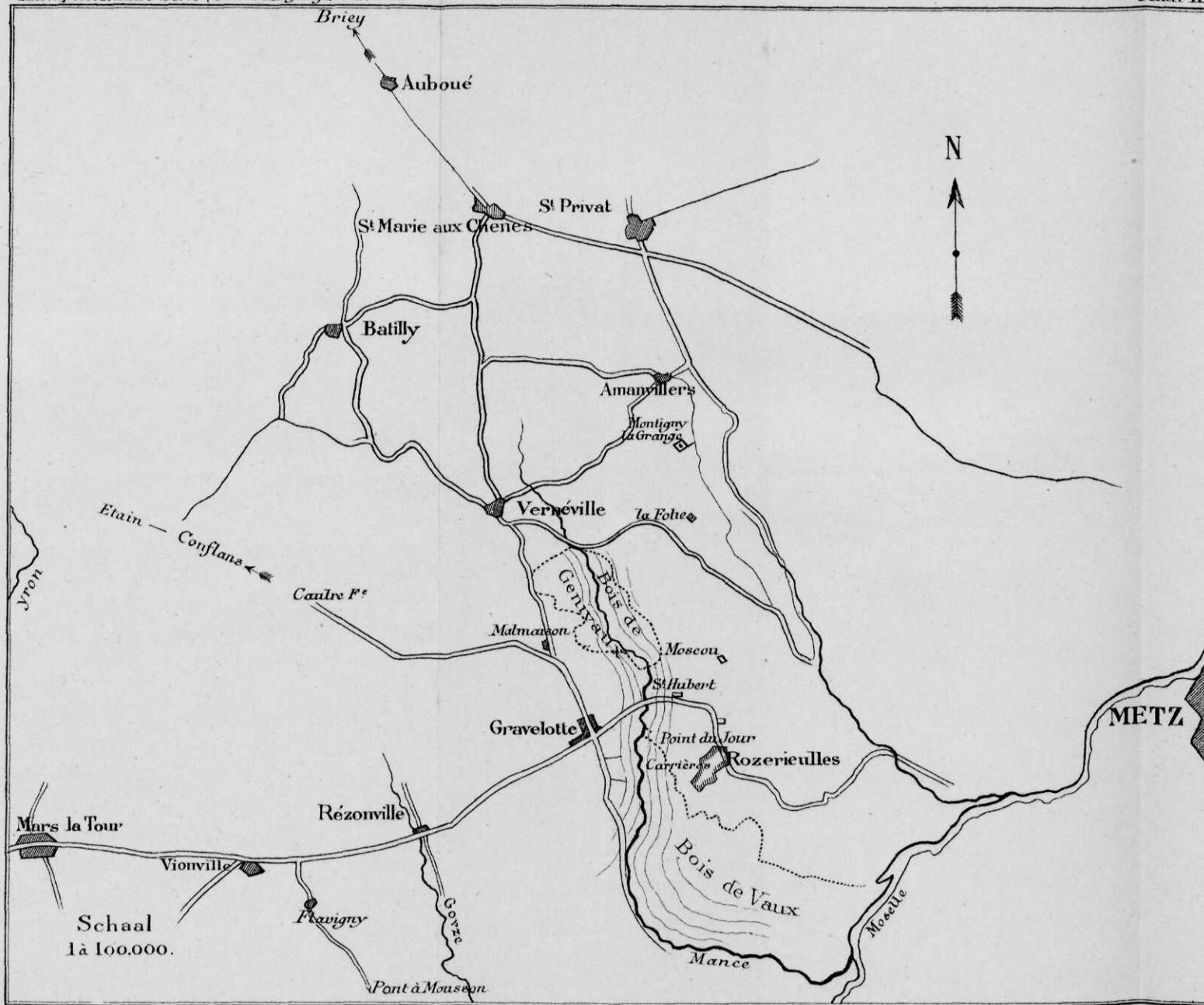

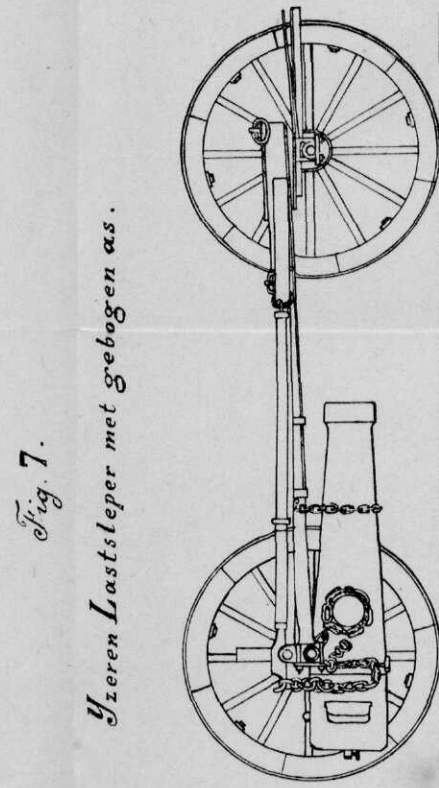
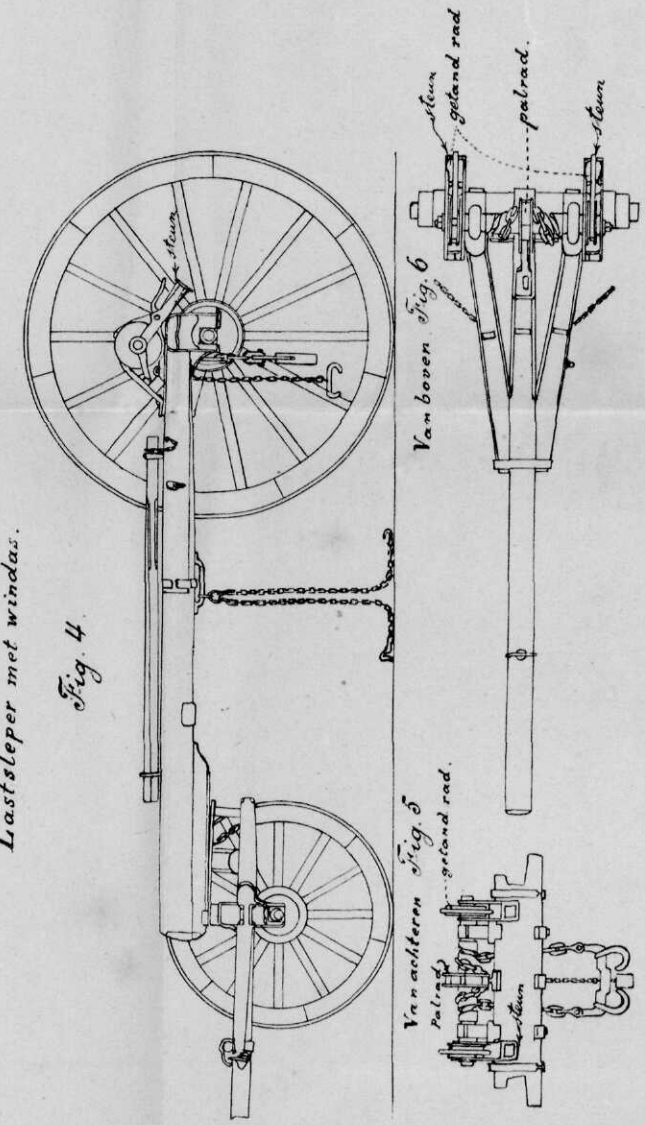
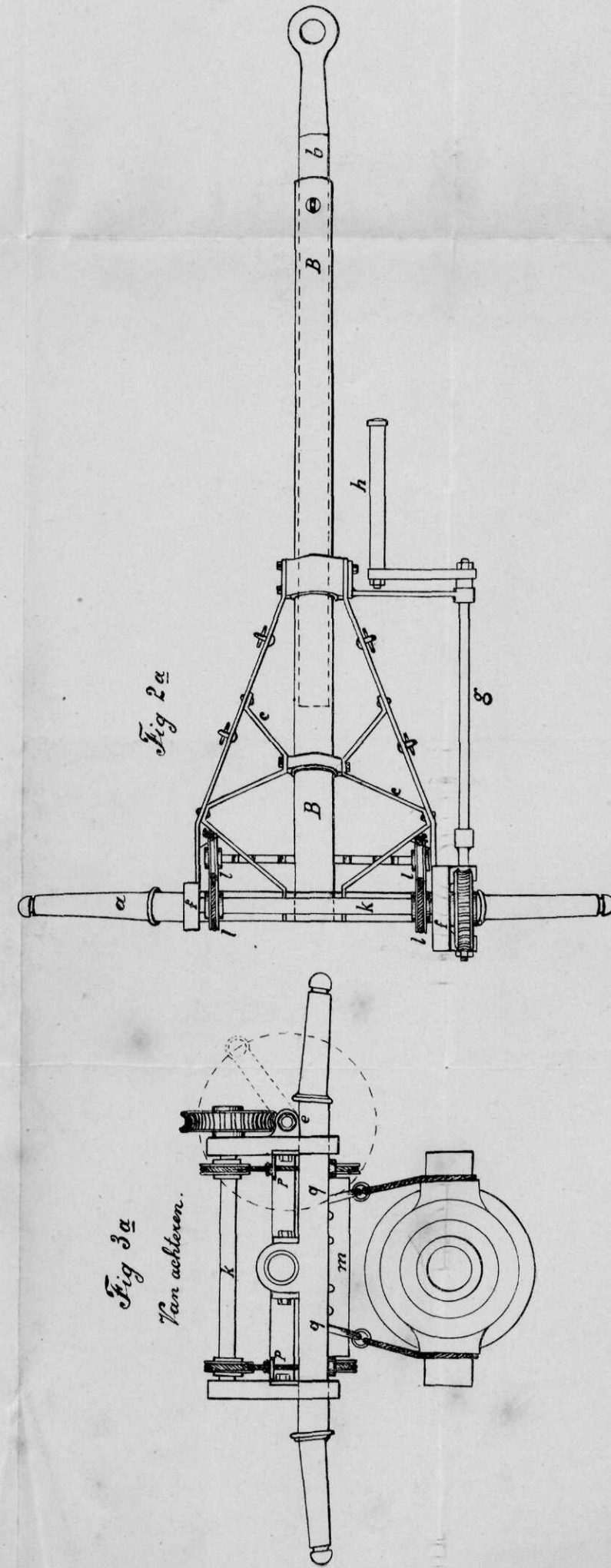
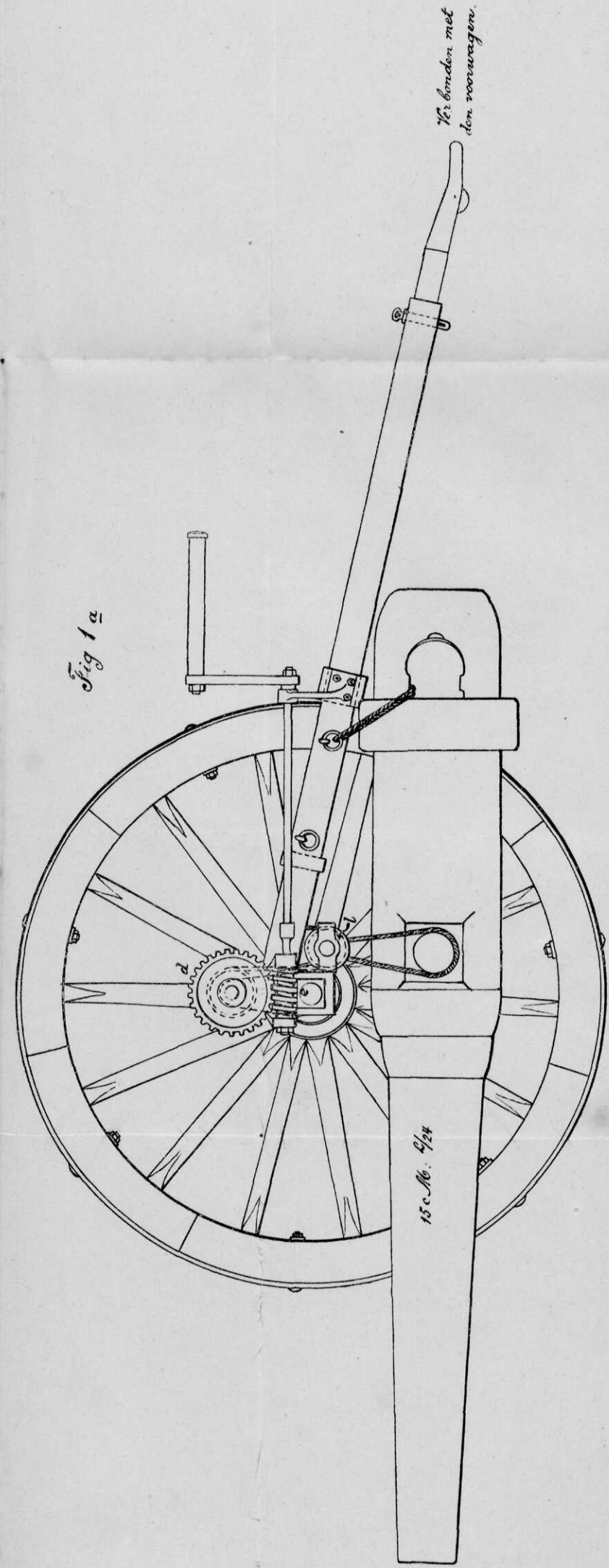
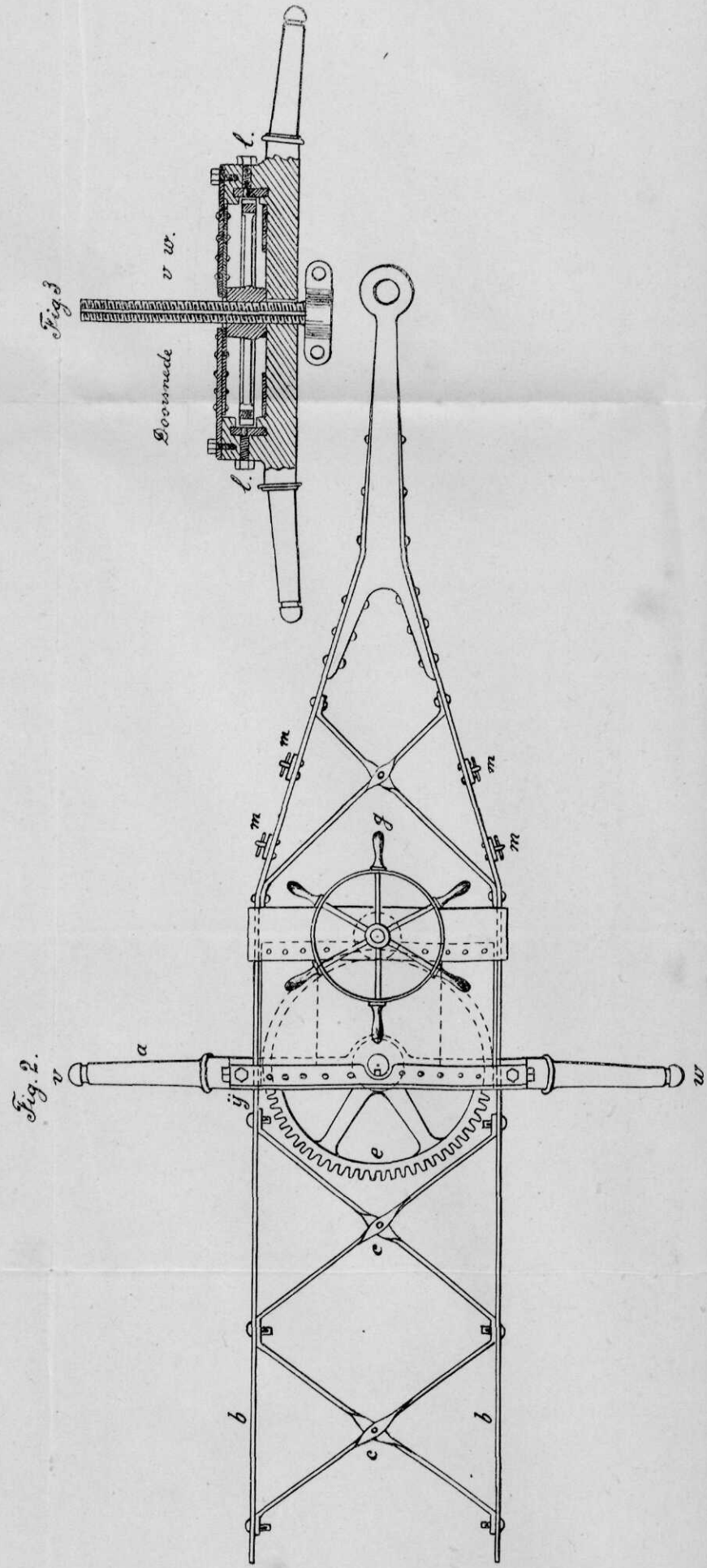
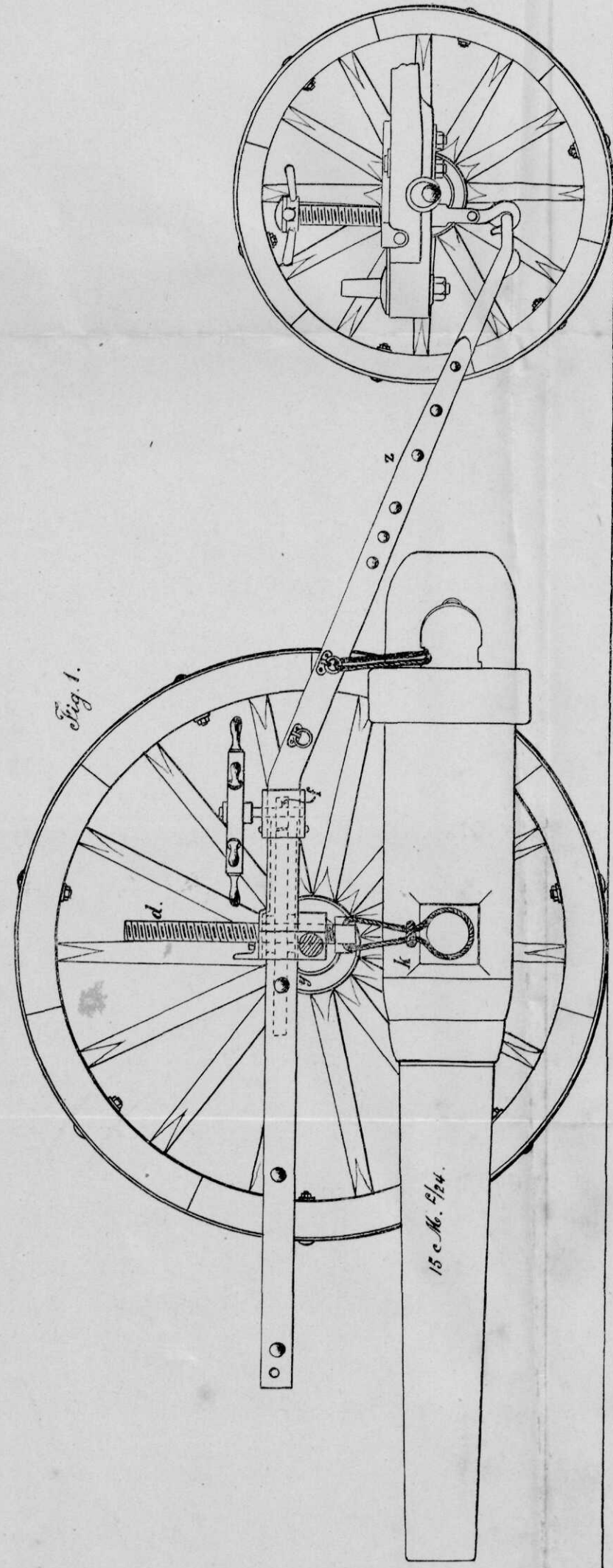

Fig. 3

Loosnede

v. w.

Te binden met  
den voorwagen.

Fig. 3 a

Van achteren.

Laststeper met windas.

Fig. 4

Fig. 7.

Izeren Laststeper met gebogen as.

Van boven Fig. 6

Van achteren Fig. 5

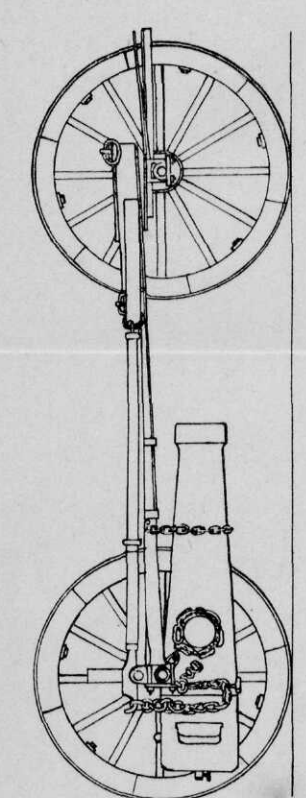
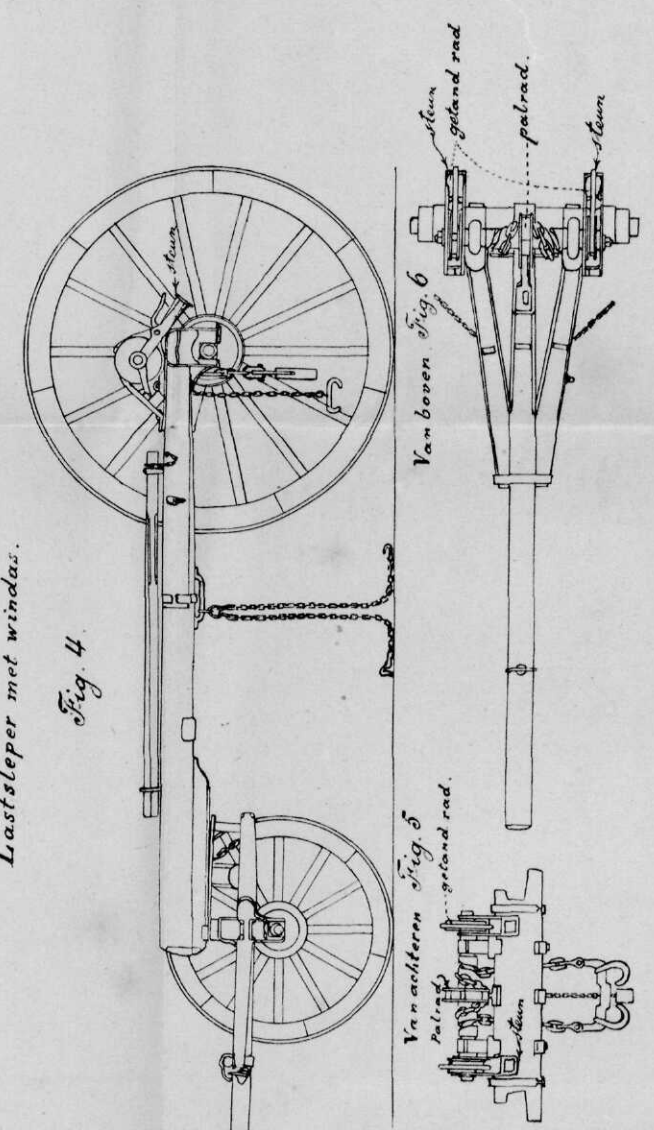
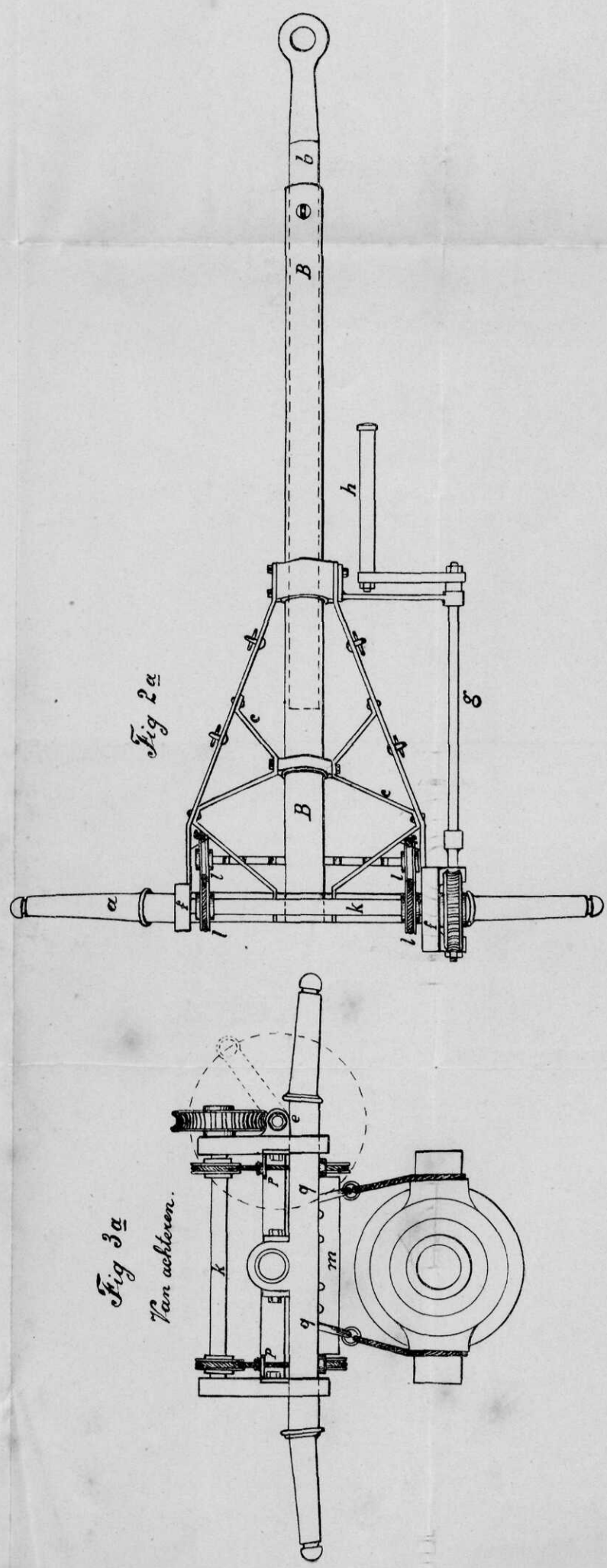
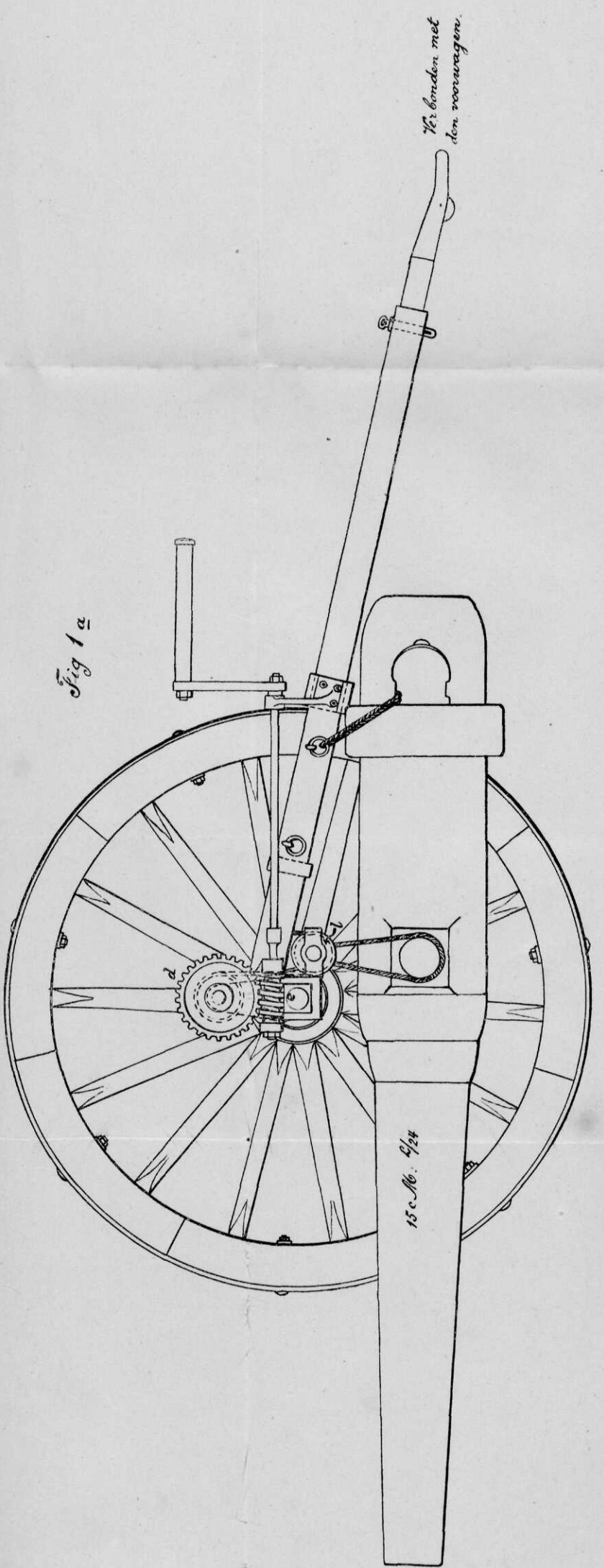
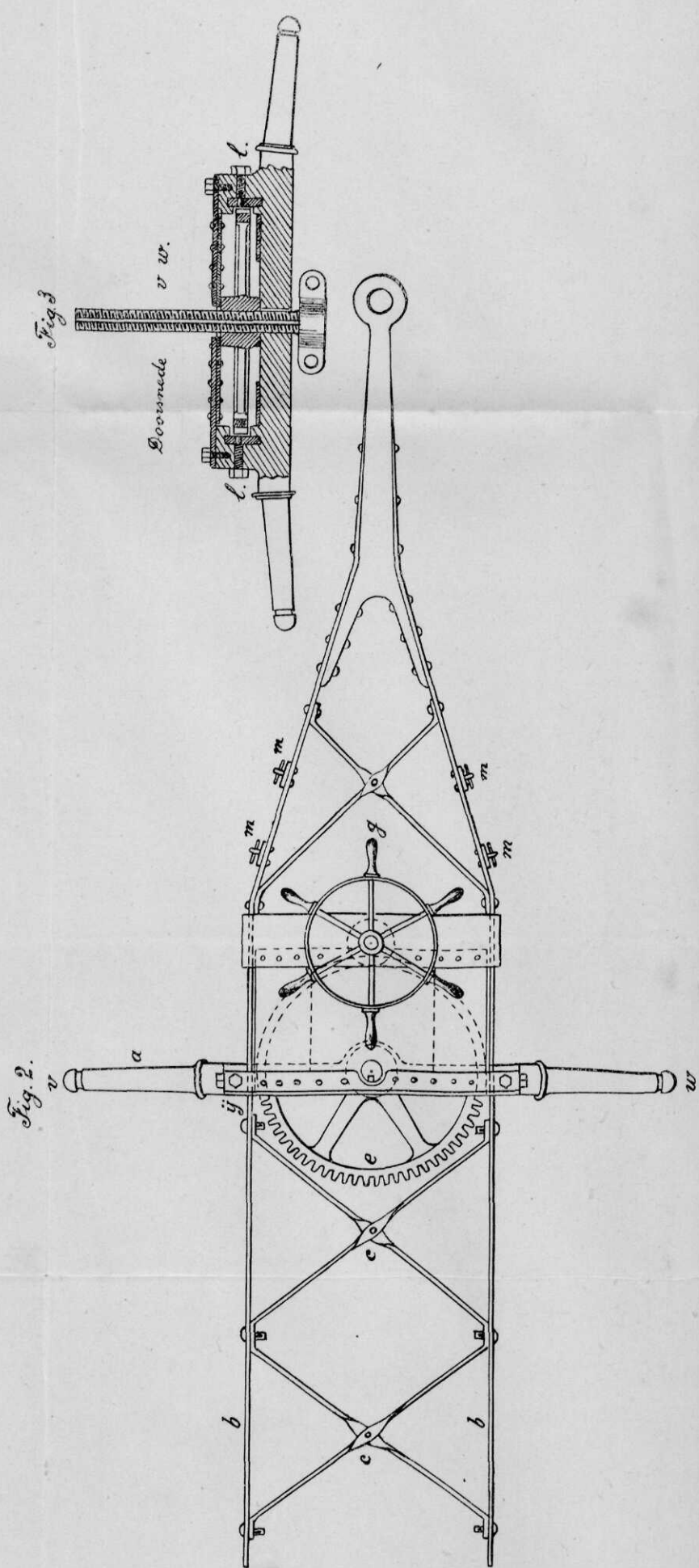
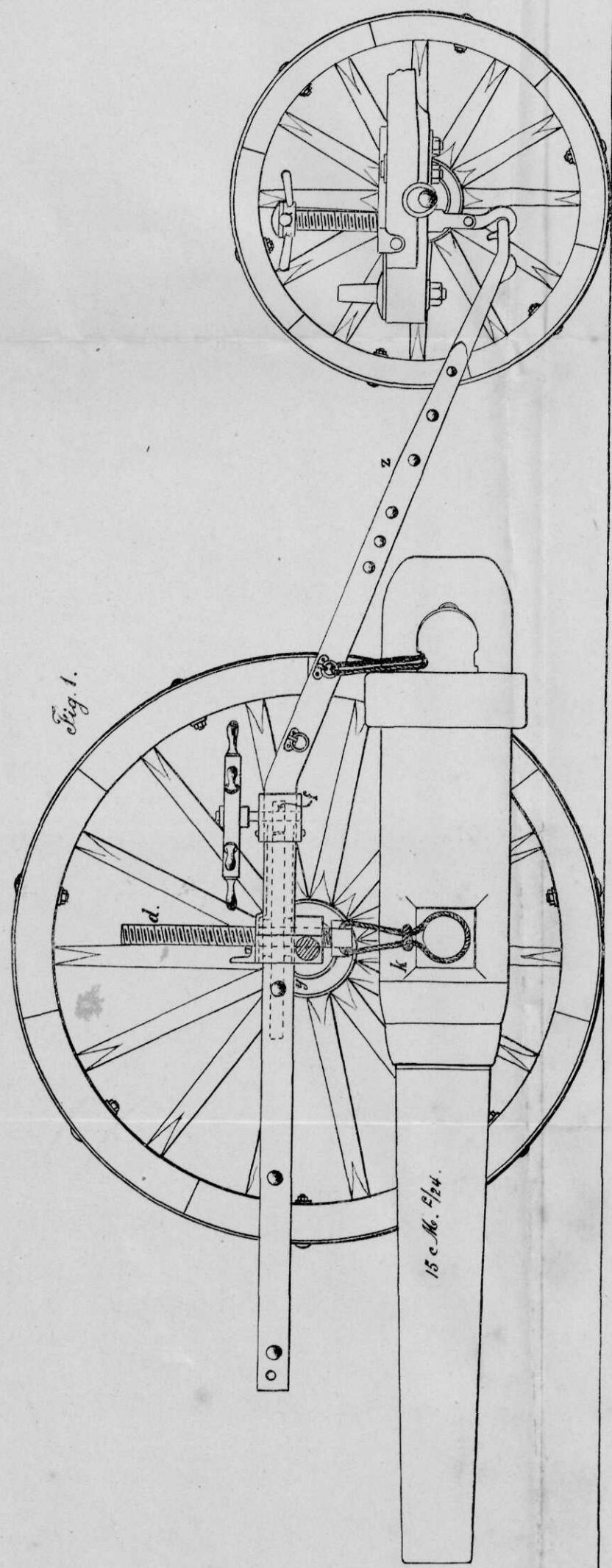

Izeren Laststeper met gebogen as.

Laststeper met windas.

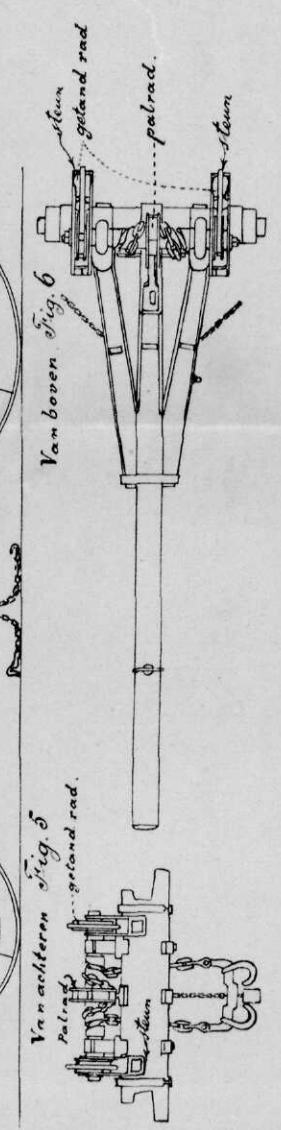

Van achteren Fig. 6

Van boven Fig. 6

Fig. 3 a  
Van achteren.

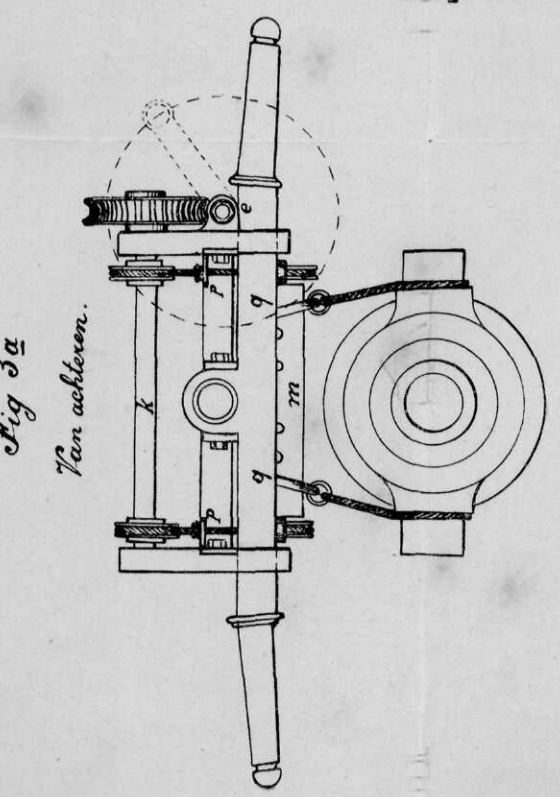

Fig. 7.

Van achteren Fig. 6

Van boven Fig. 6

# De Vliegerballons Parseval-Siegsfeld.

Fig. 1. Aanzicht. (1.200.)

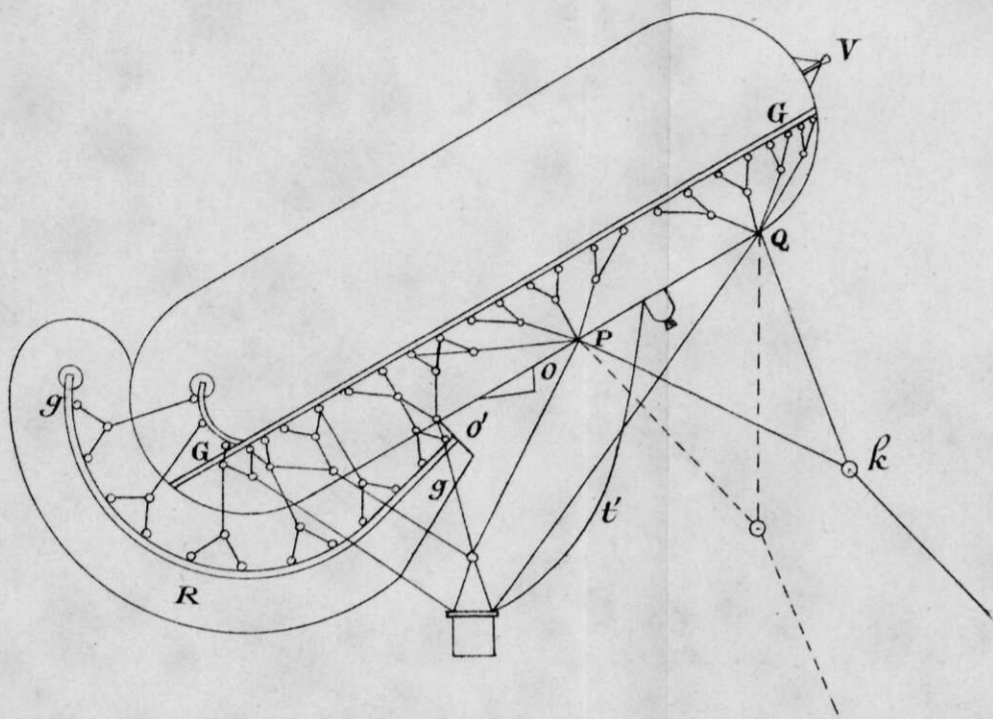

Fig. 2. Langsdoorsnede. (1.200.)

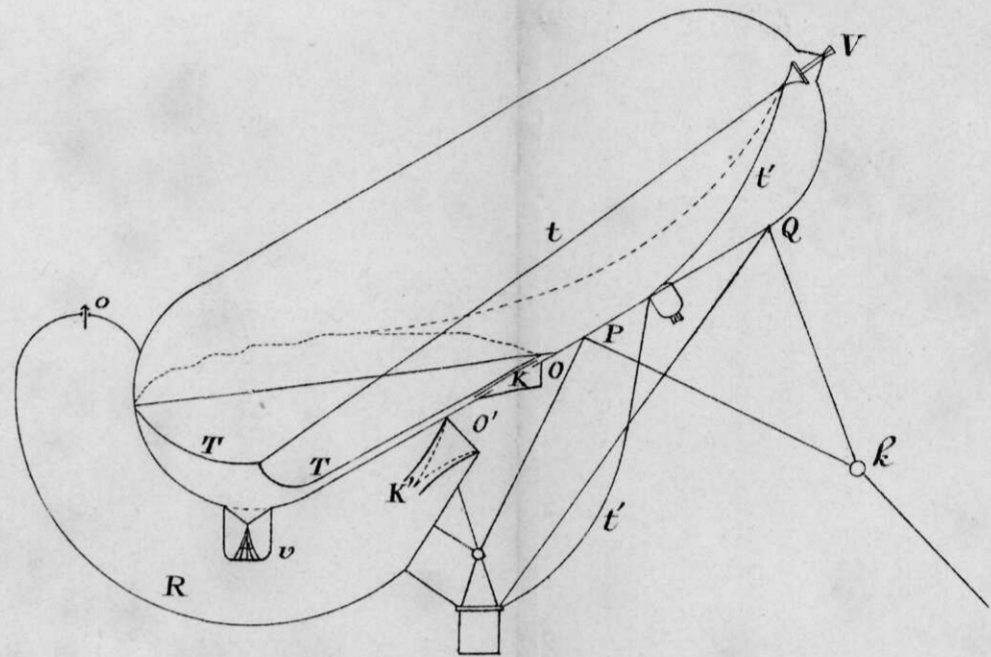

Fig. 3. Gierbeweging

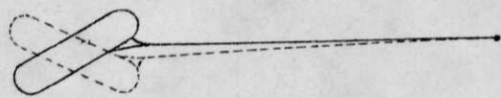

Fig. 4. Slingerbeweging

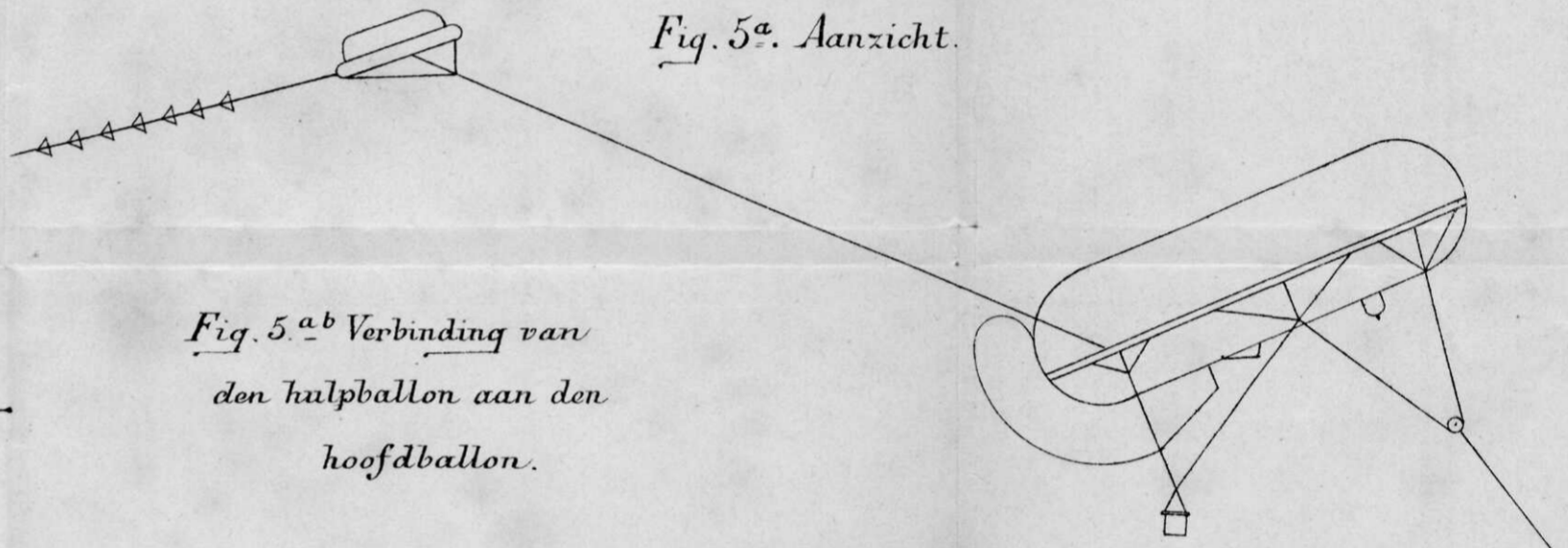
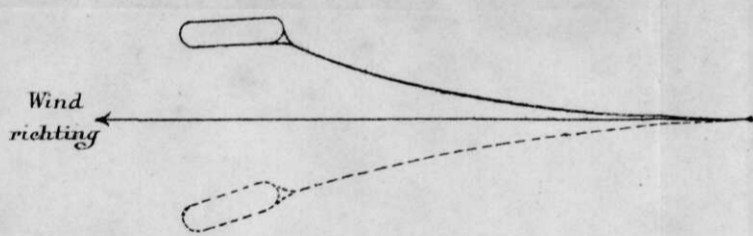

Fig. 5<sup>a</sup>. Aanzicht.

Fig. 5.<sup>a</sup><sup>b</sup> Verbinding van den hulpballon aan den hoofdballon.

Fig. 5<sup>b</sup> Plattegrond

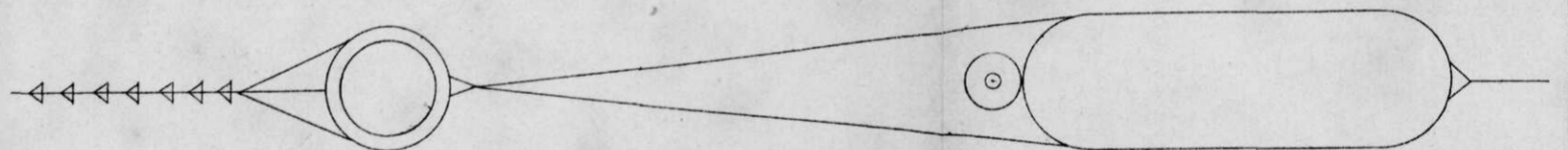

Fig. 6. Doorsnede over den hulpballon.

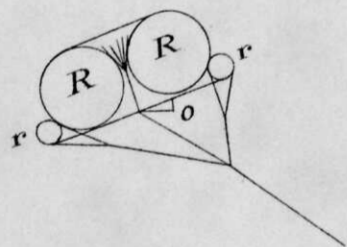

Fig. 8. Dwarsdoorsnede (met zeilen) loodrecht op de lengteas

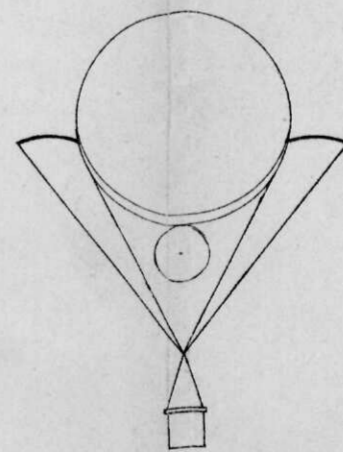

Fig. 7. Plattegrond. (met zeilen.)

