

Fig. 1.

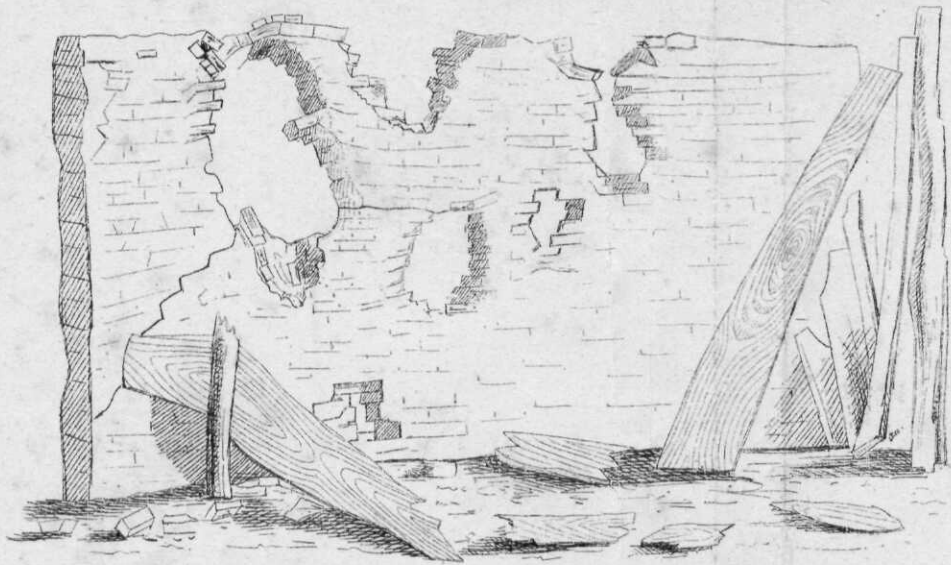

Fig. 2.

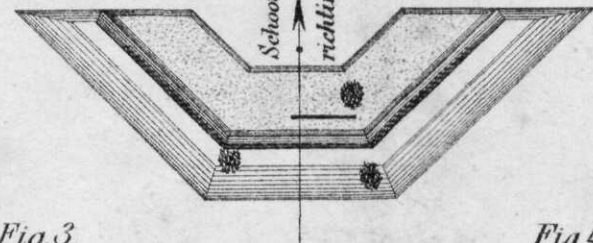

Fig. 3.

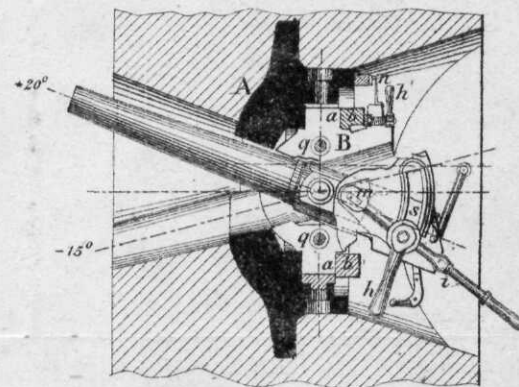

Fig. 4.

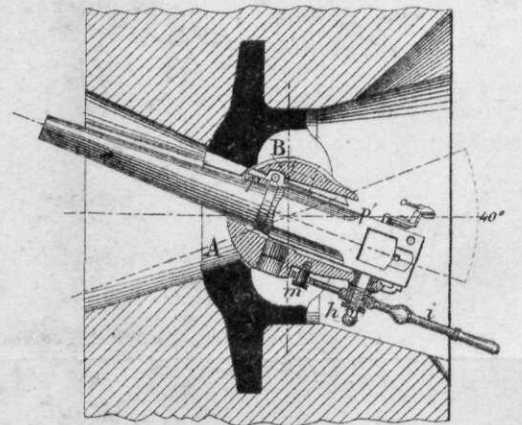

Fig. 7.

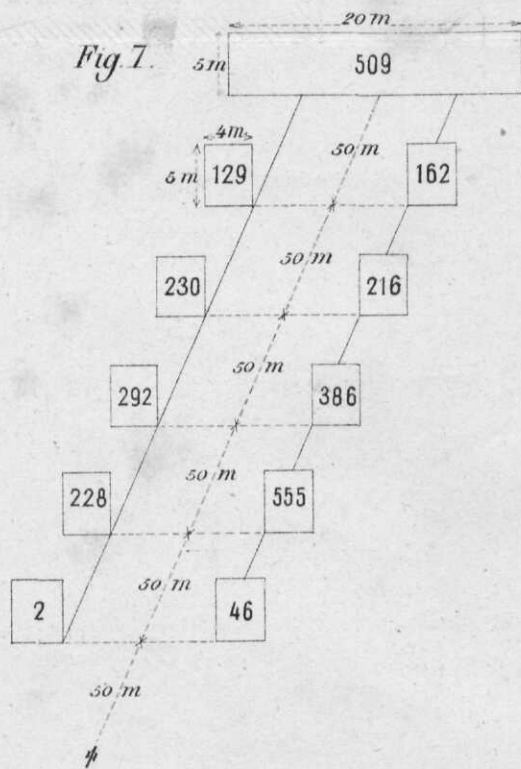

Fig. 5.

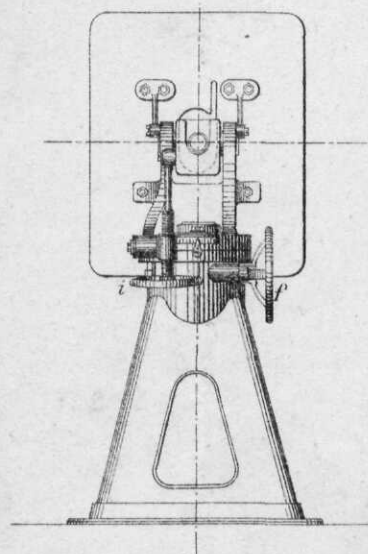

Fig. 6.

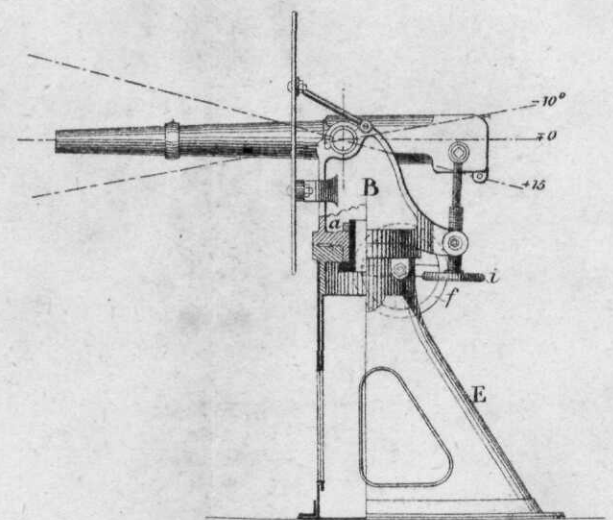

Fig. 1 (1:10).

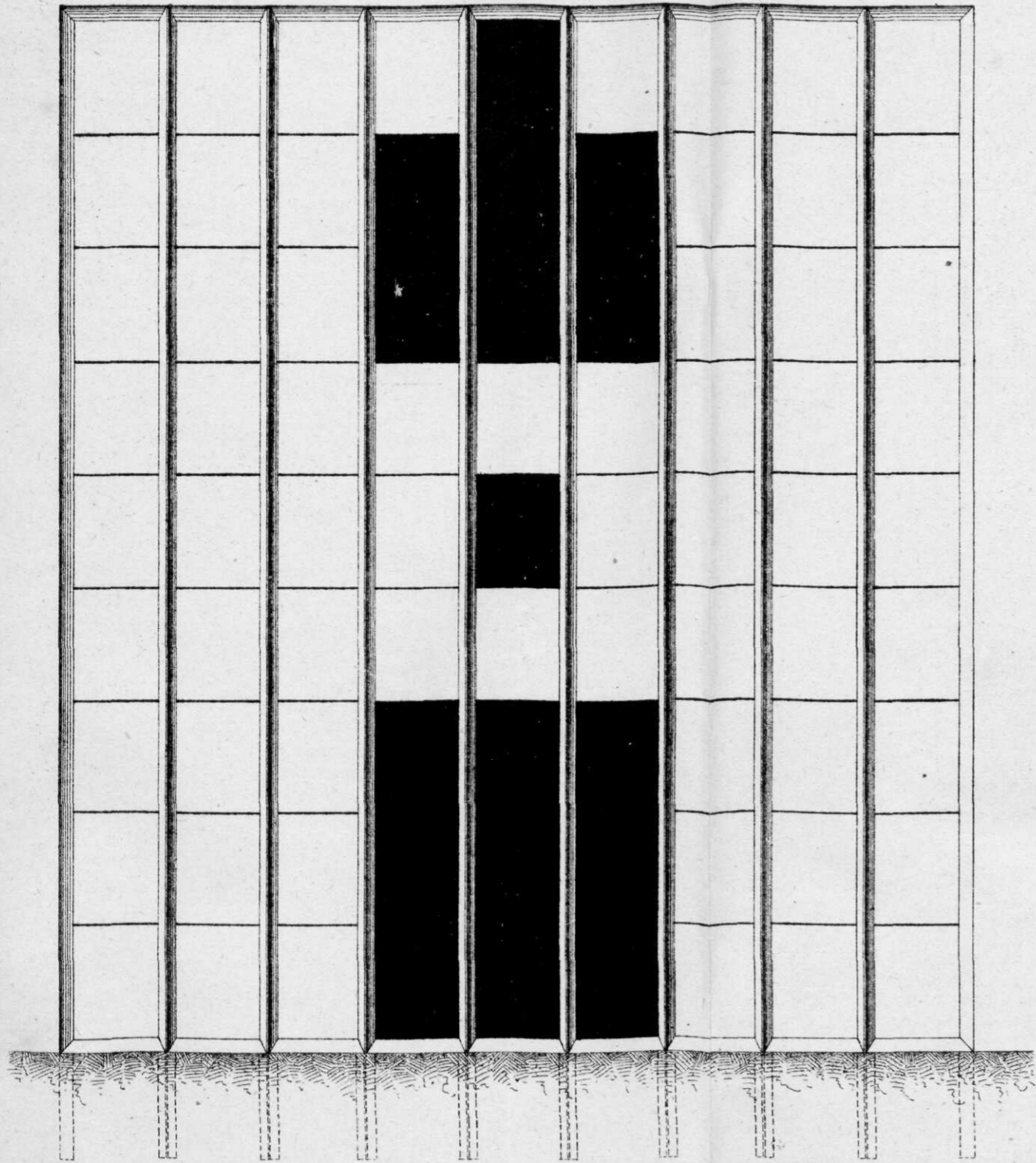

Fig. 2 (1:2).

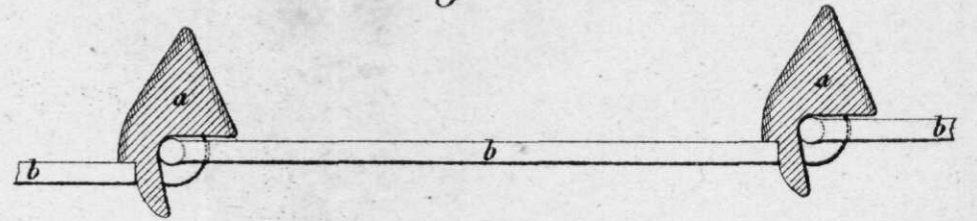

Fig. 3 (1:2).

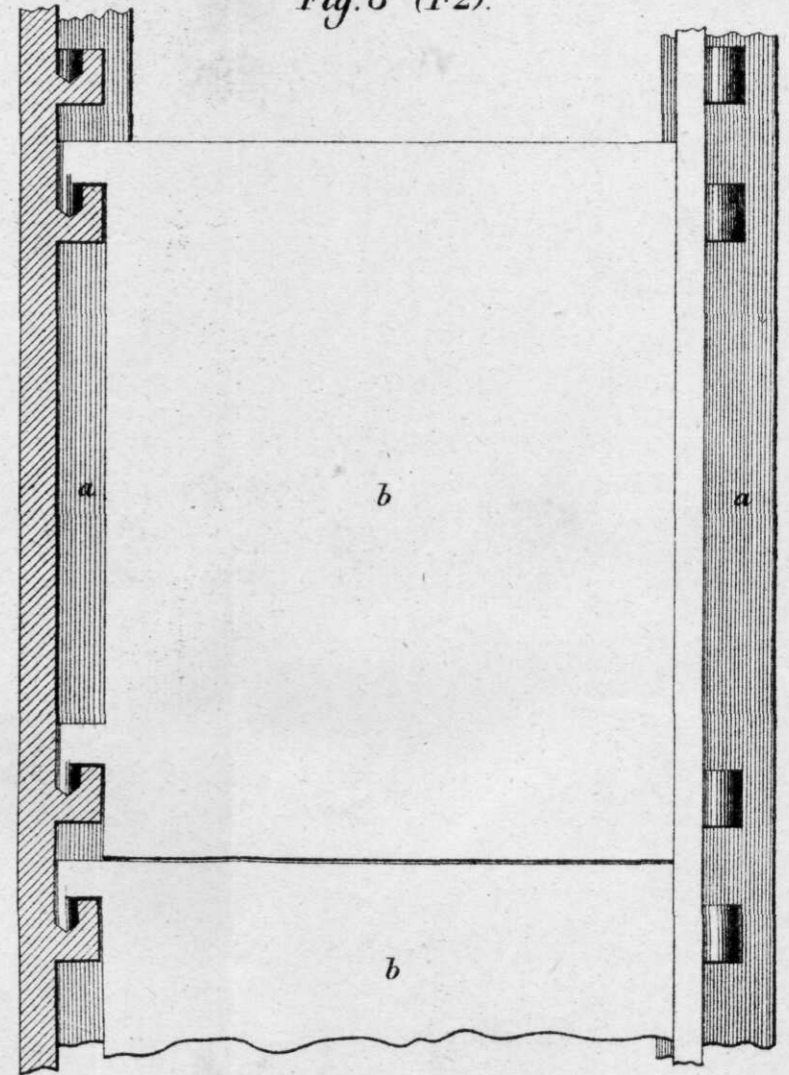

Fig. 1 (1:10).

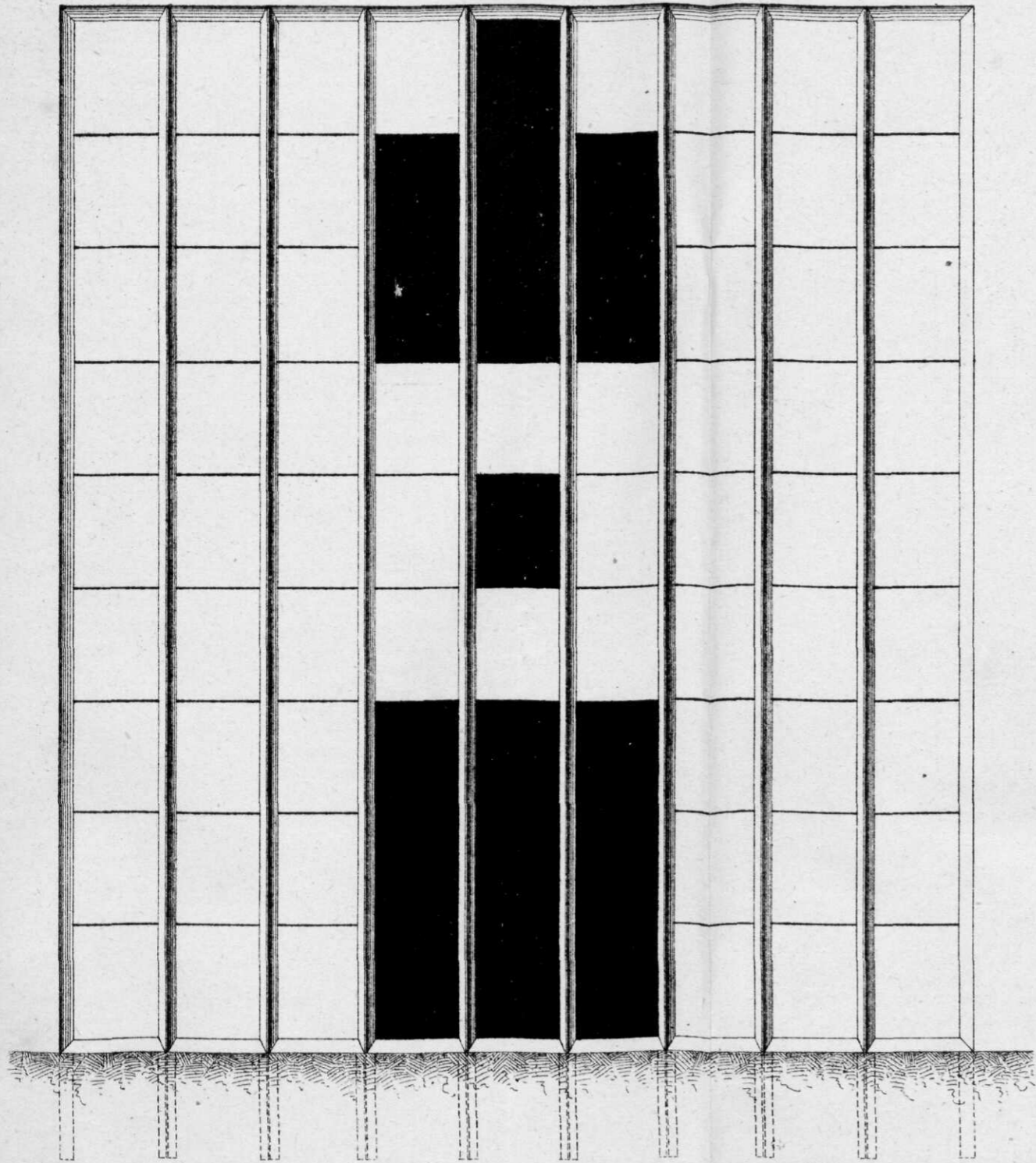

Fig. 2 (1:2).

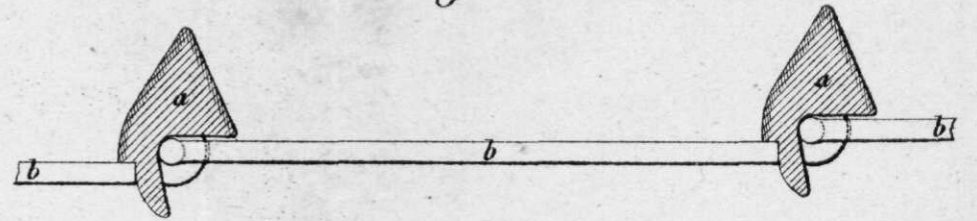

Fig. 3 (1:2).

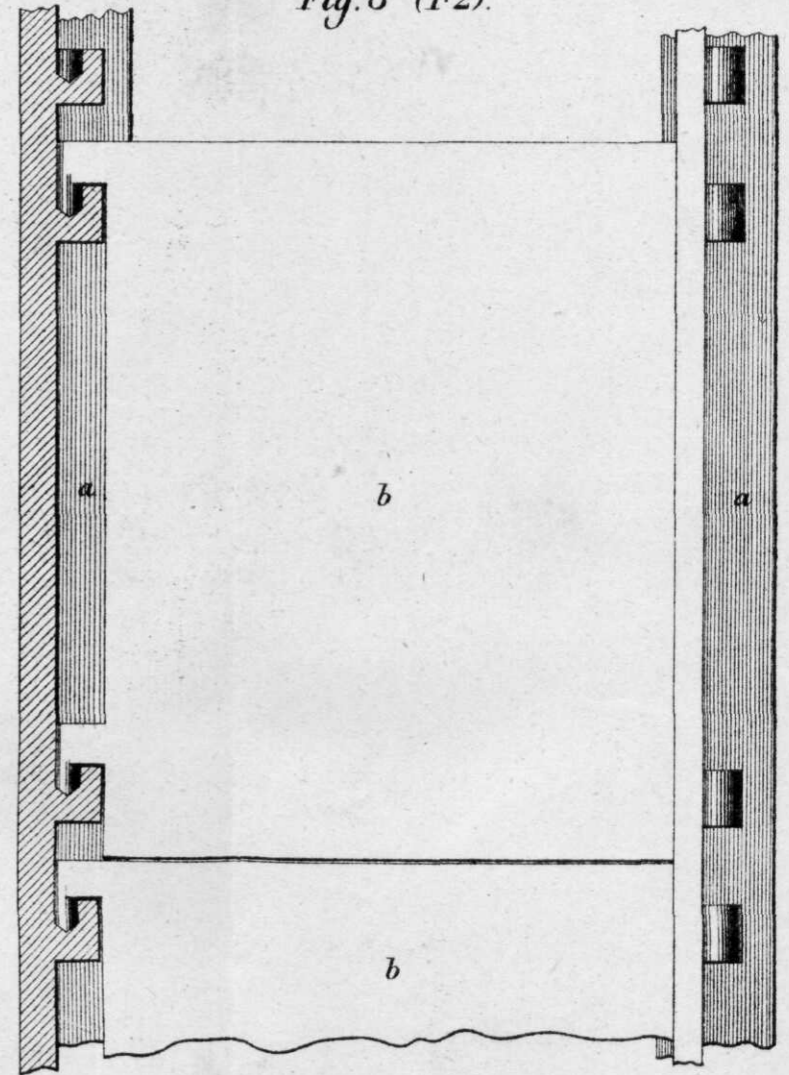

Fig. 1. (1:30)

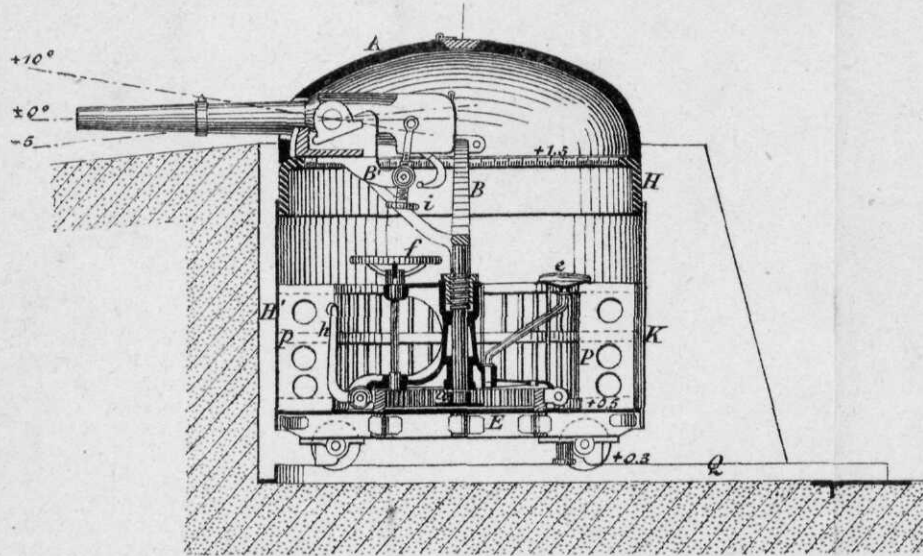

Fig. 2. (1:30)

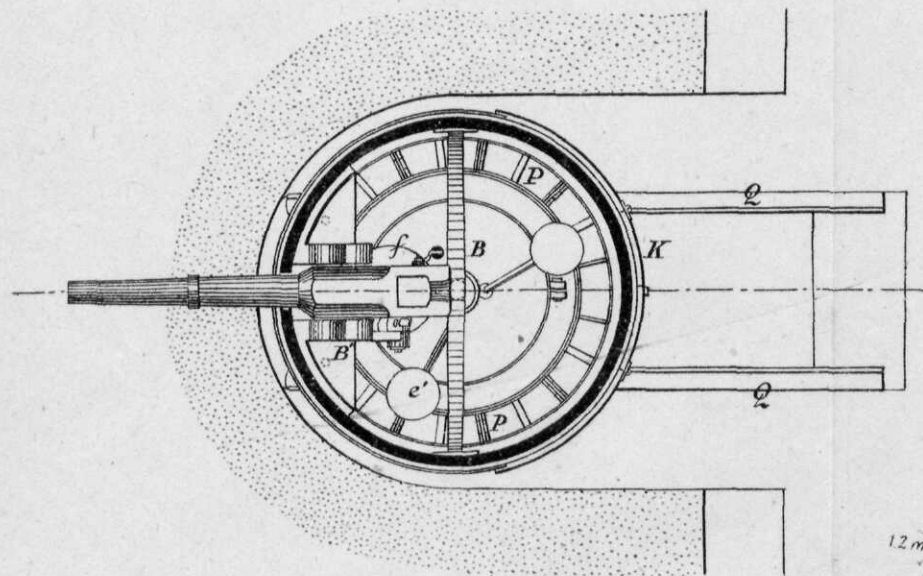

Fig. 3. (1:60)

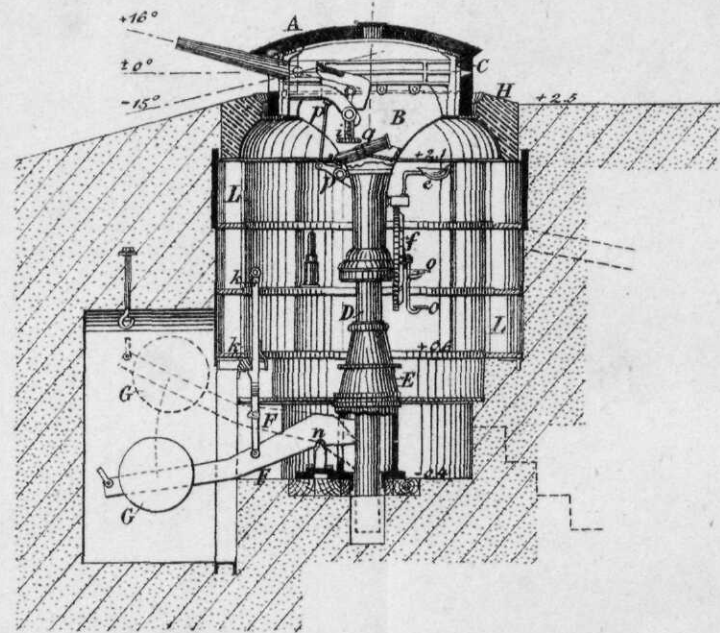

Fig. 4. (1:60)

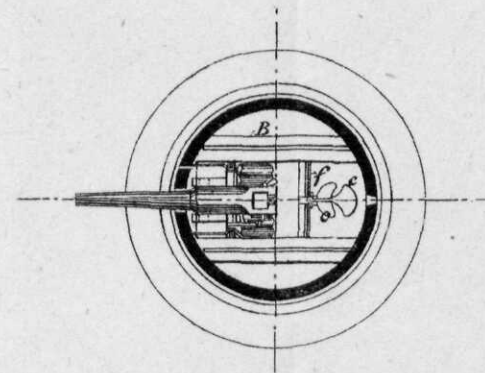

Fig. 5.

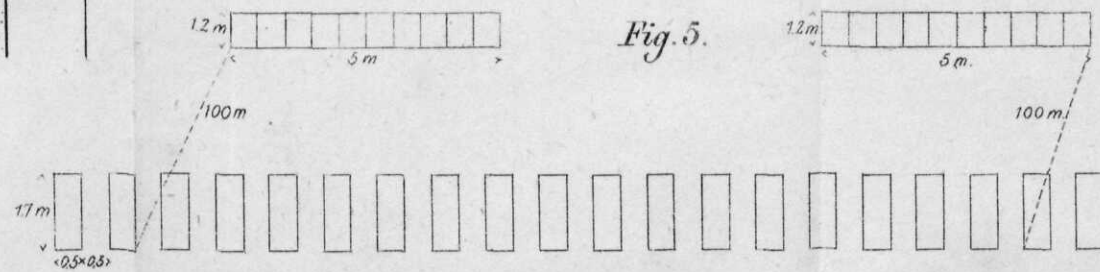

Fig. 1.

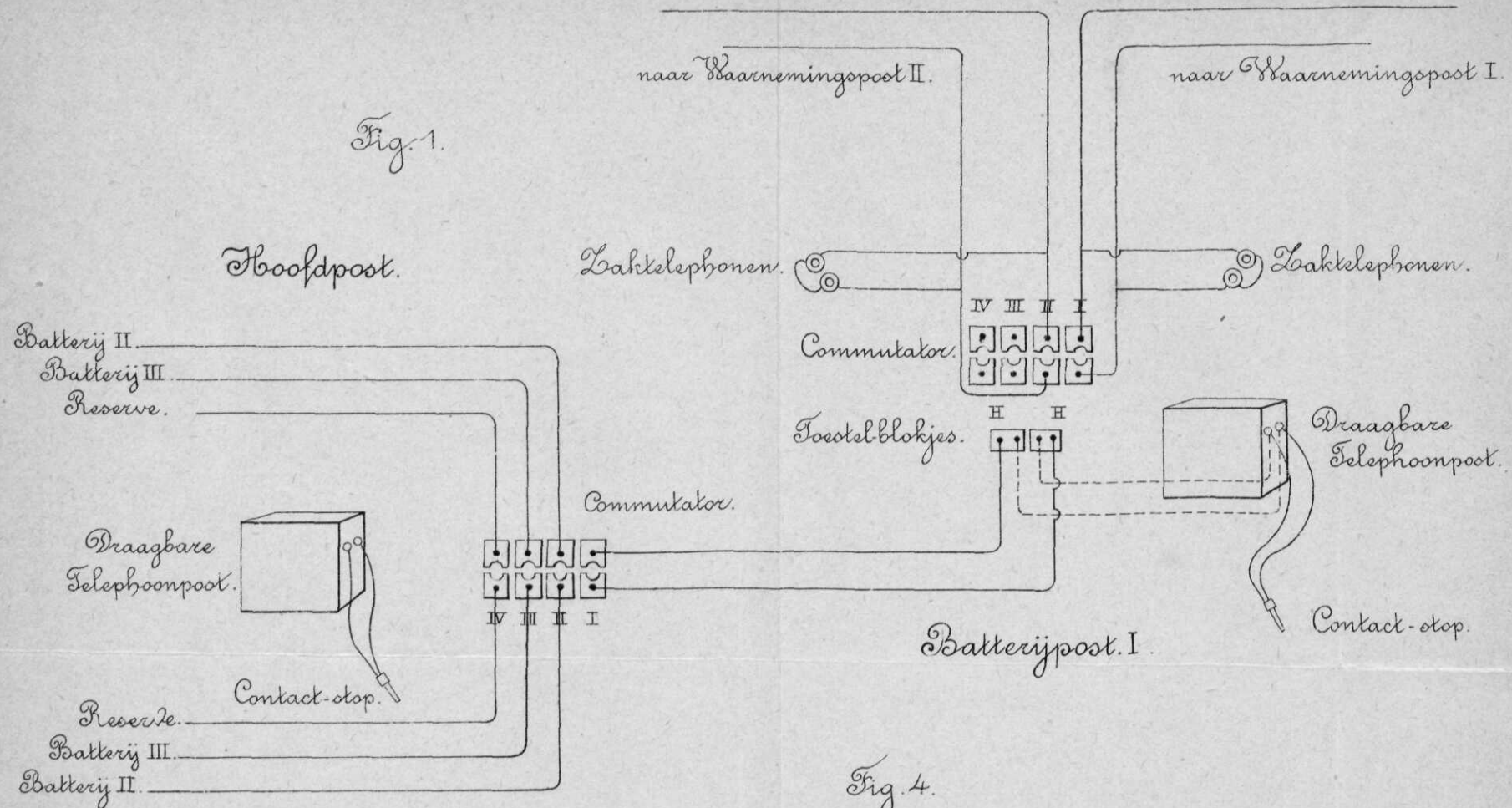

Fig. 2.

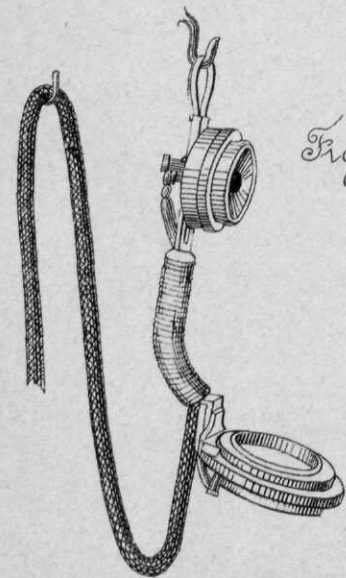

Fig. 4.

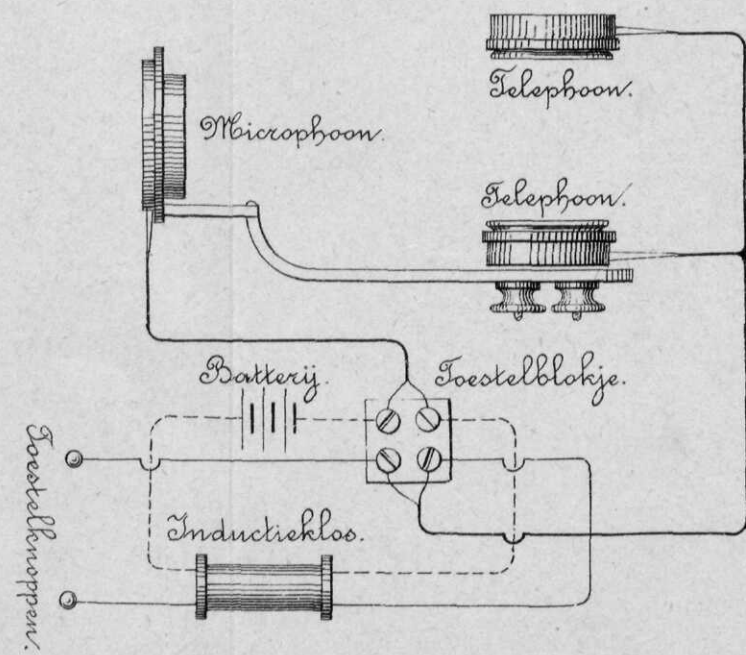

Fig. 3.

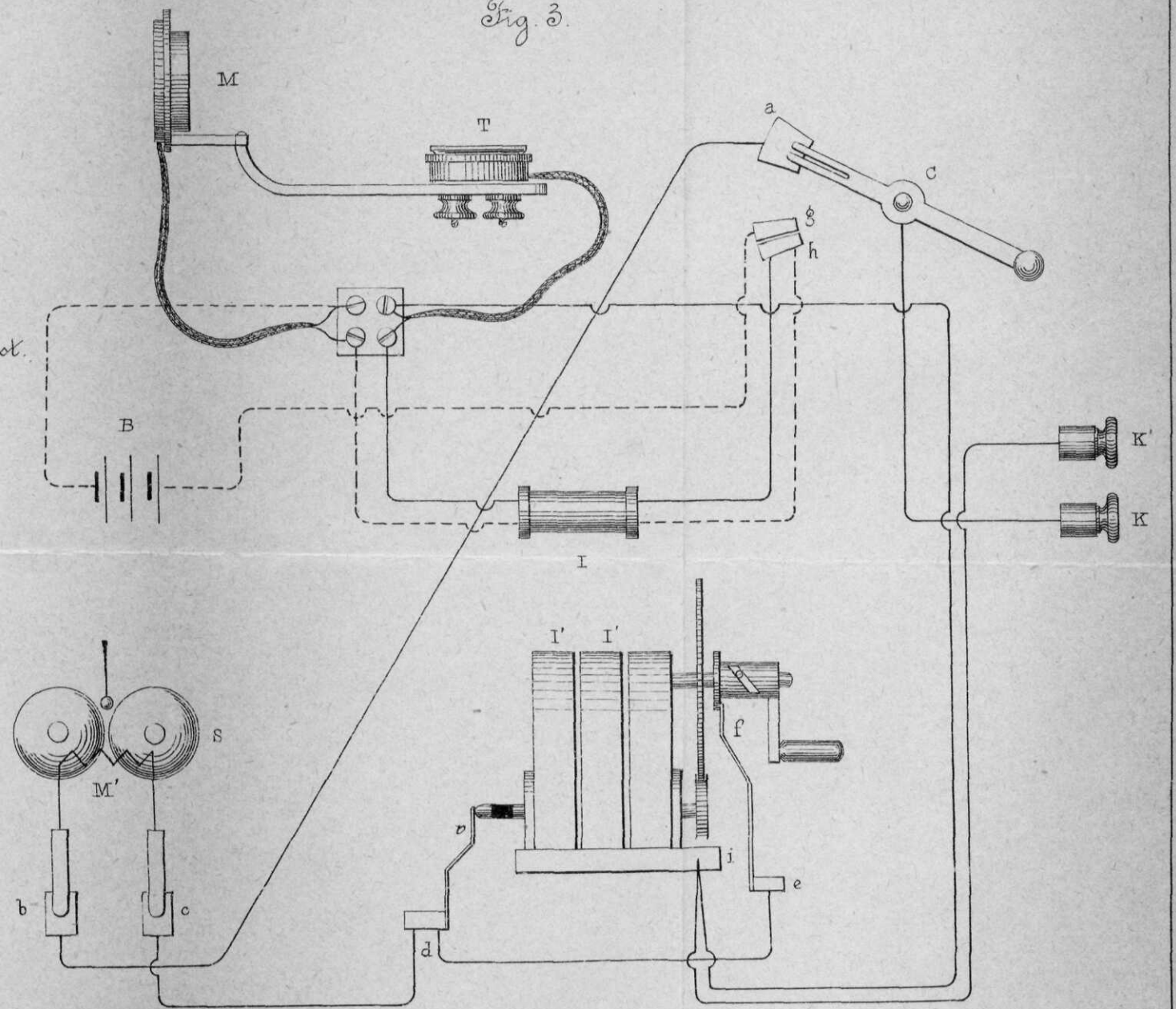

Fig. 1. Opstelling op 1200 M van de vijandelijke stelling. (Diepte 180 M.)

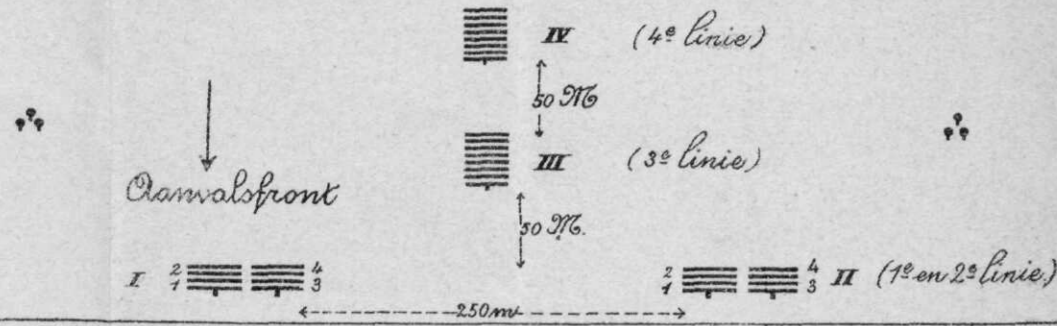

Fig. 2. Voorste afdelingen op 1000 M. (diepte 370 M.)

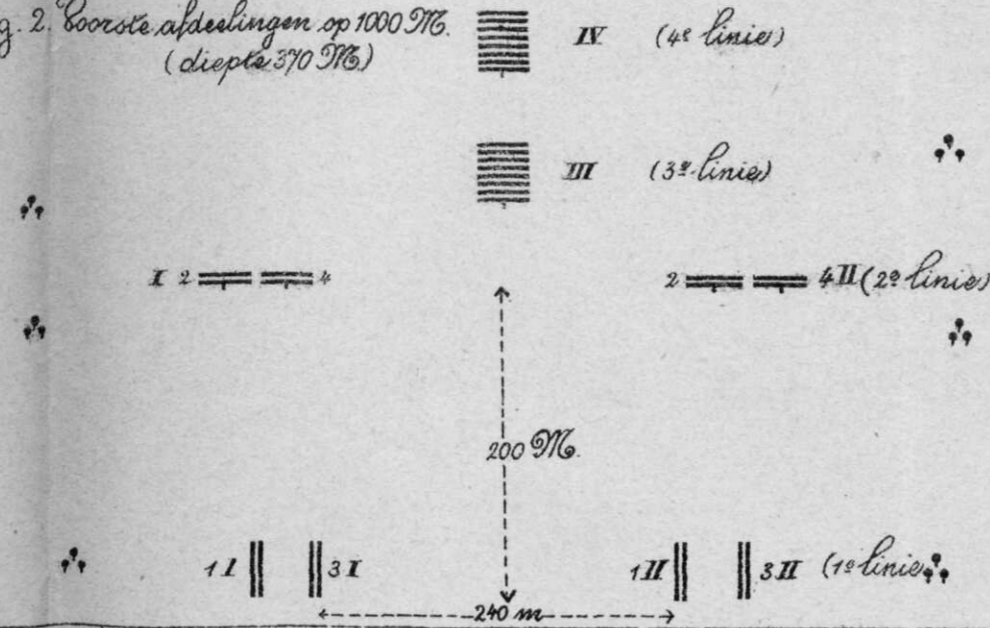

Fig. 3. Voorste afdelingen op 900 M. (diepte 470 M.)

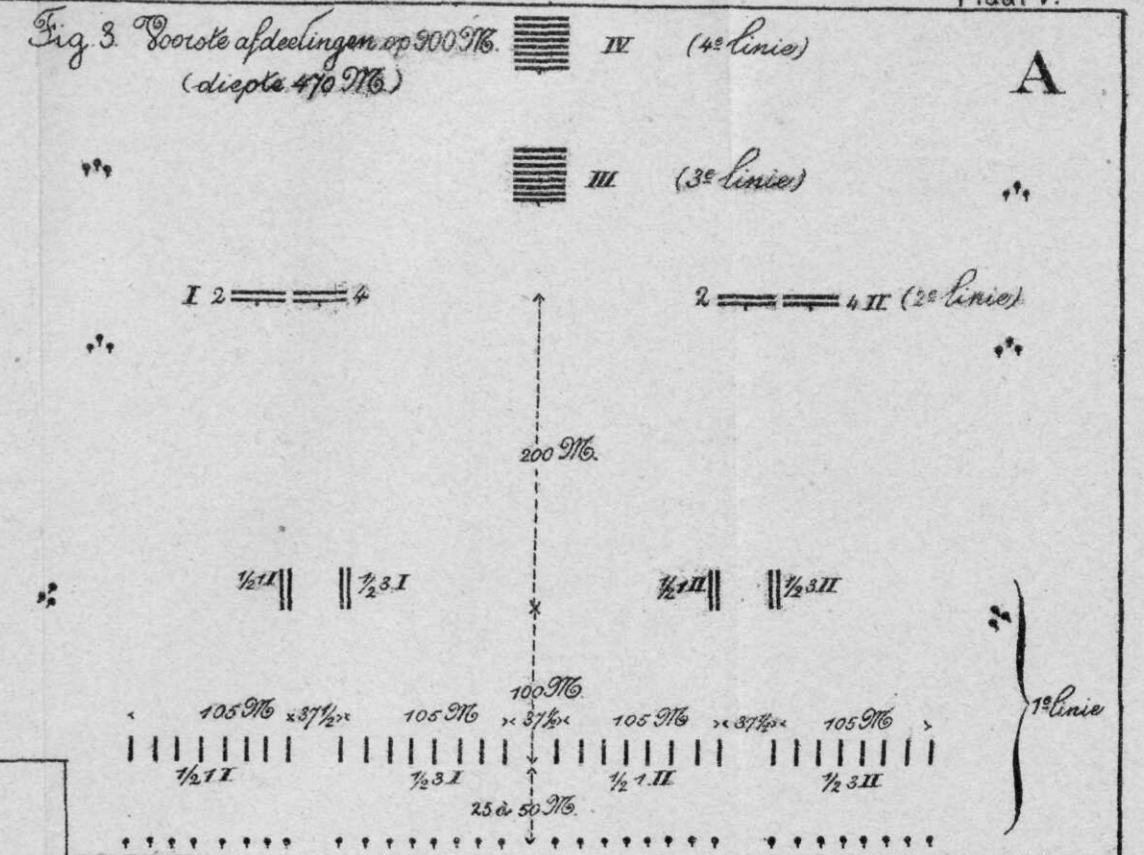

Fig. 6. Voorste linies op 600 M. Diepte 870 m.

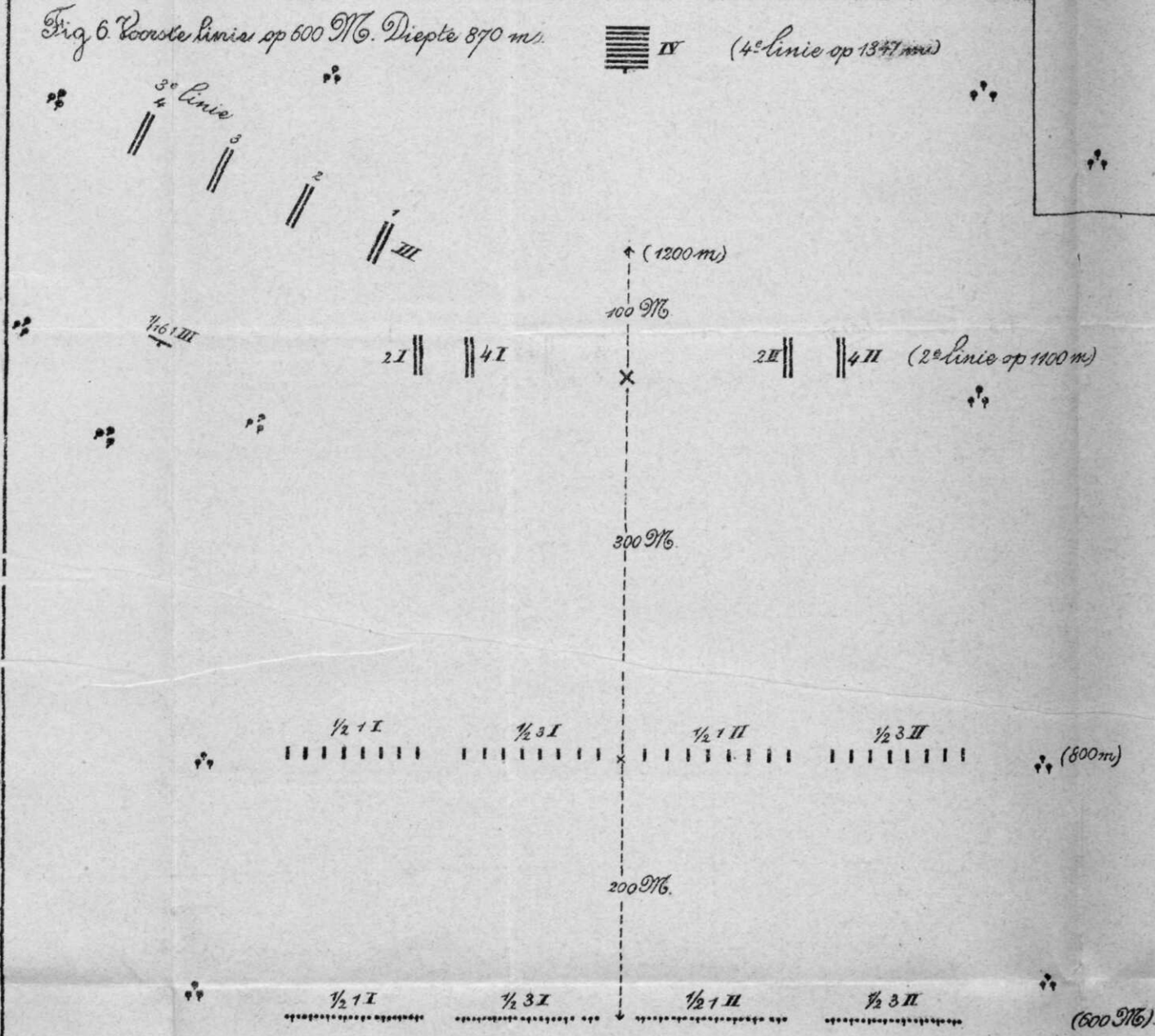

Fig. 5. Voorste linie op 700 M. (diepte 570 M.)

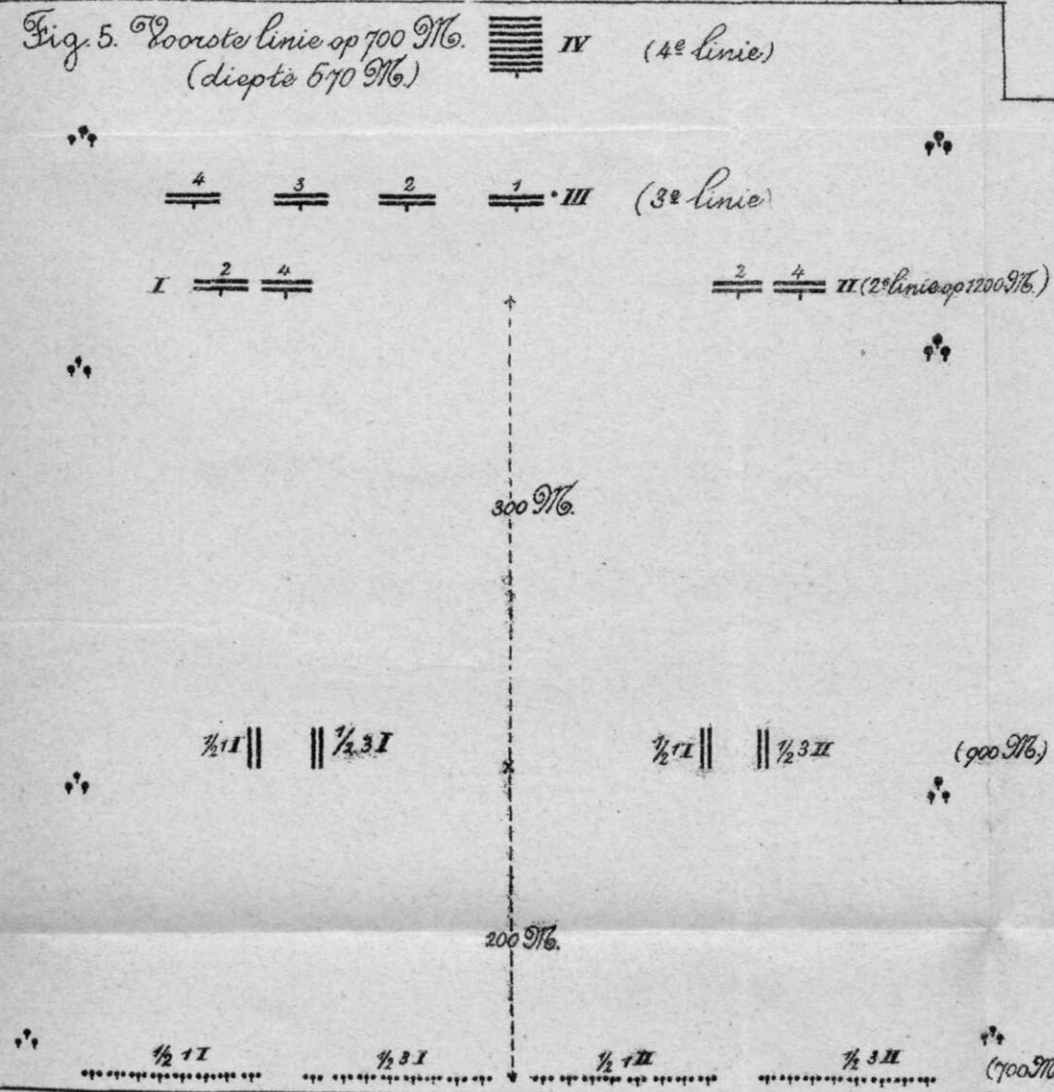
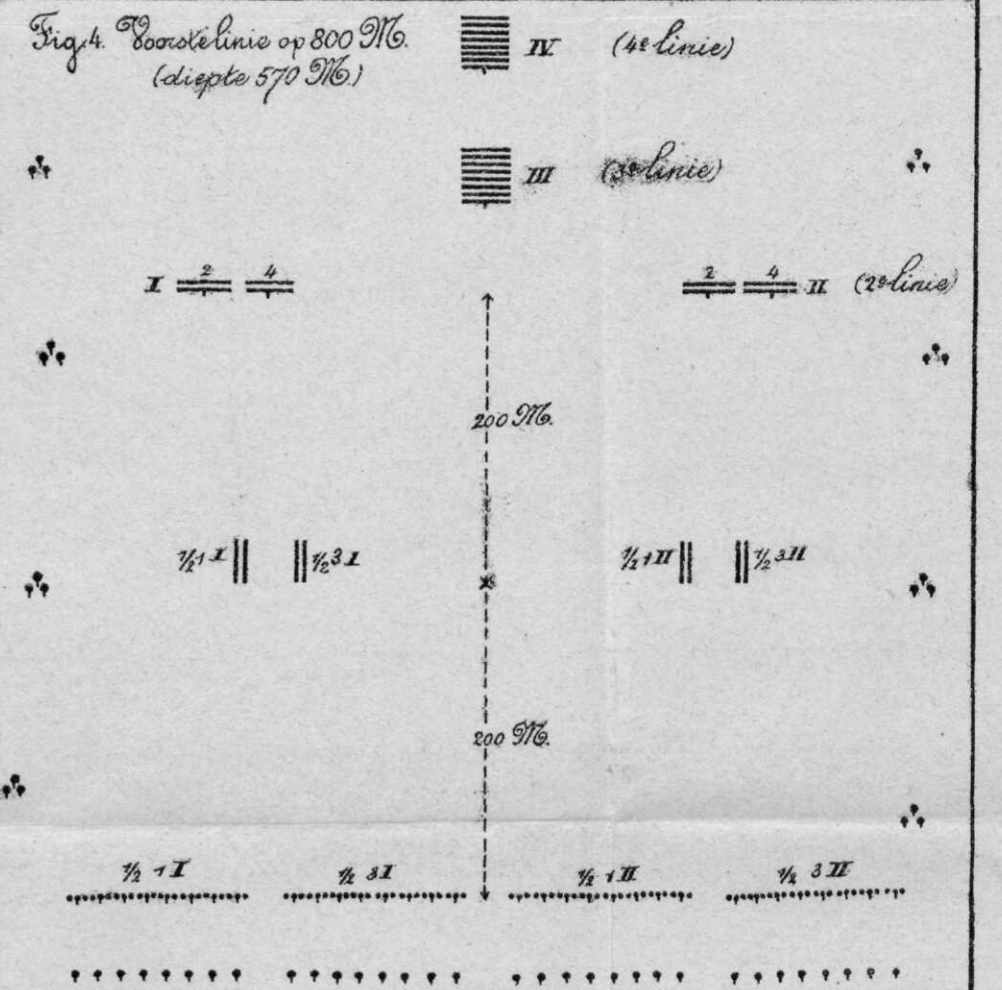

Fig. 4. Voorste linie op 800 M. (diepte 570 M.)



B

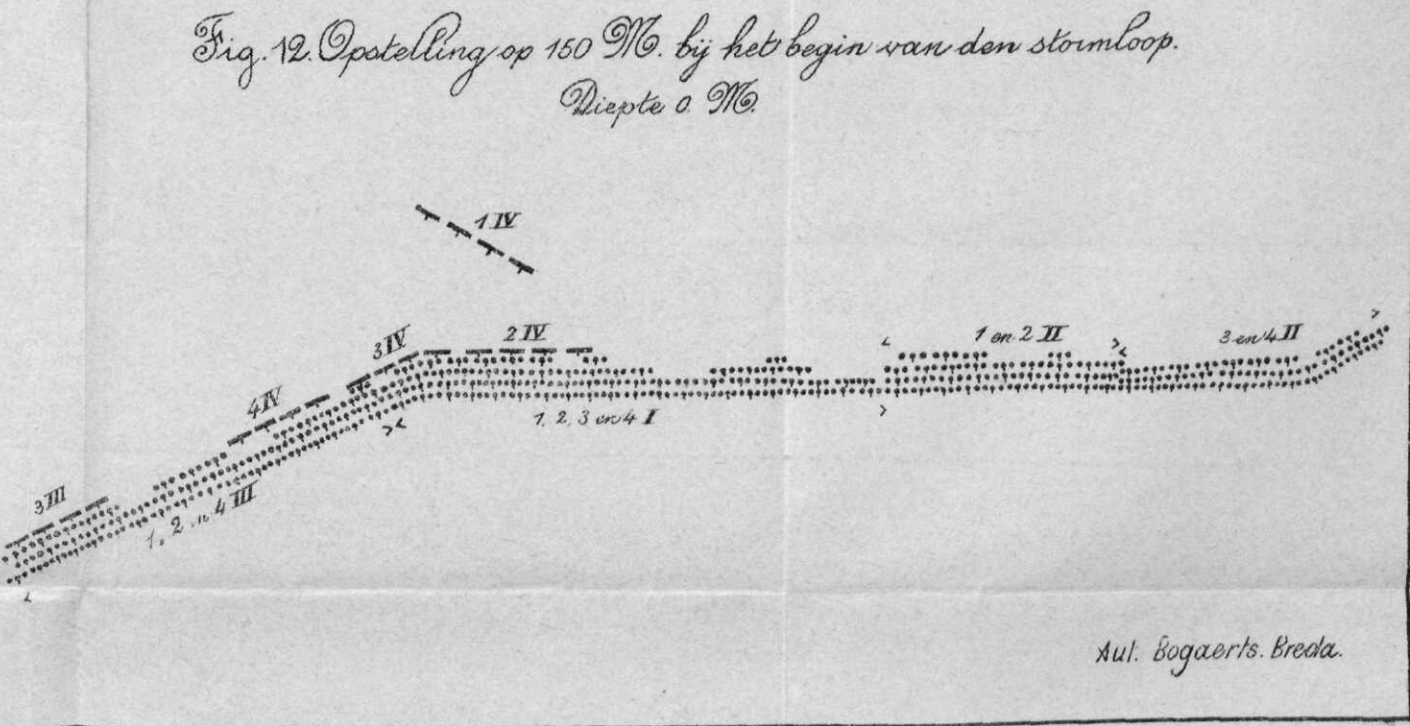
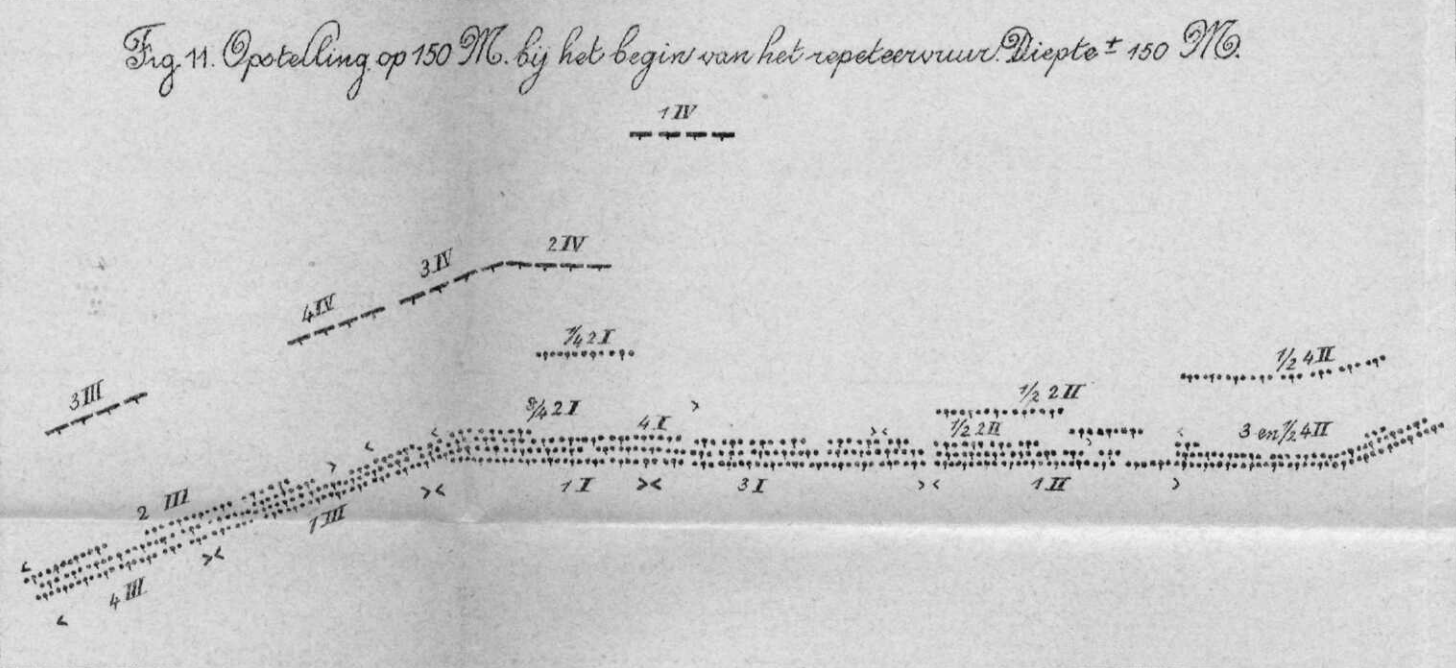
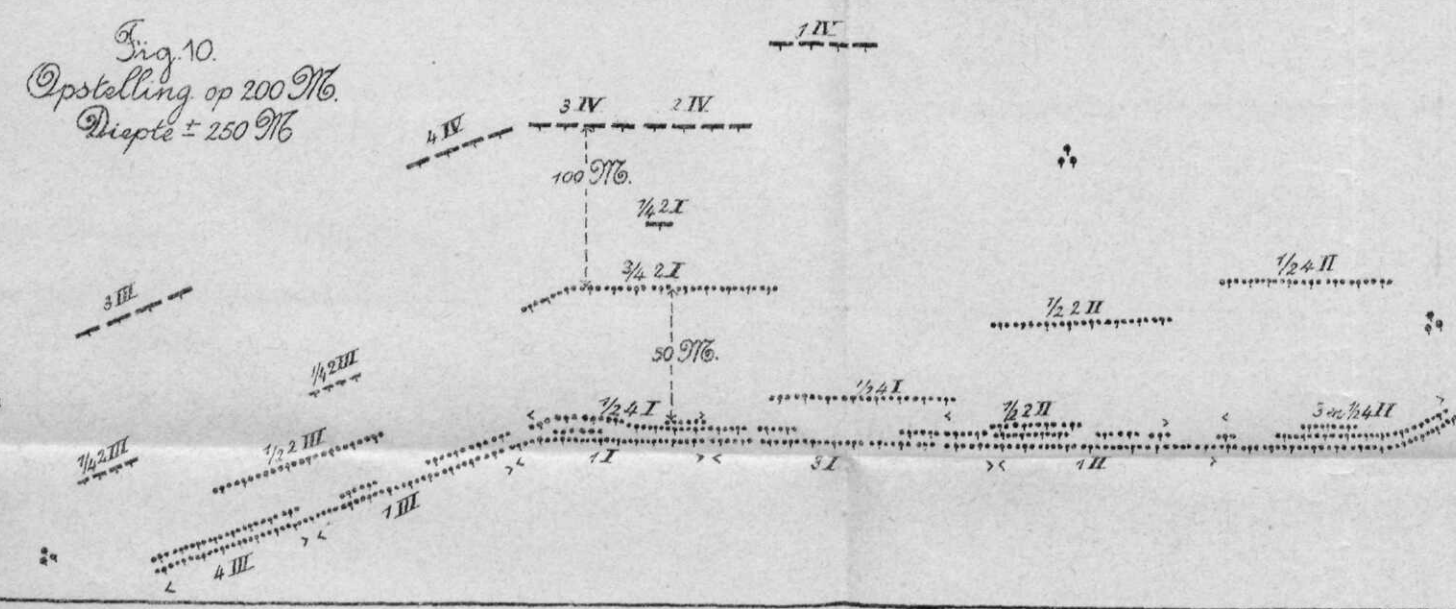
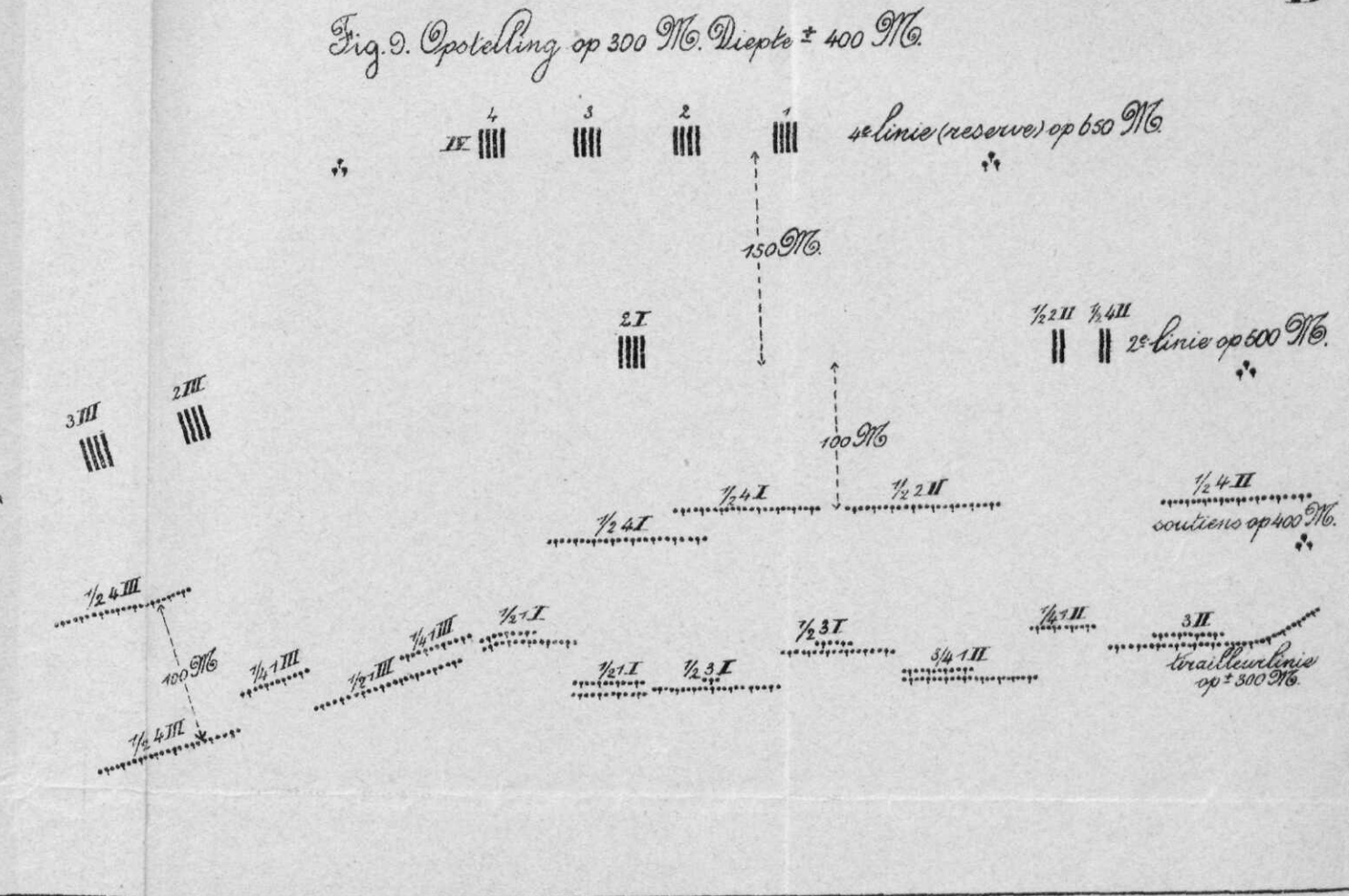
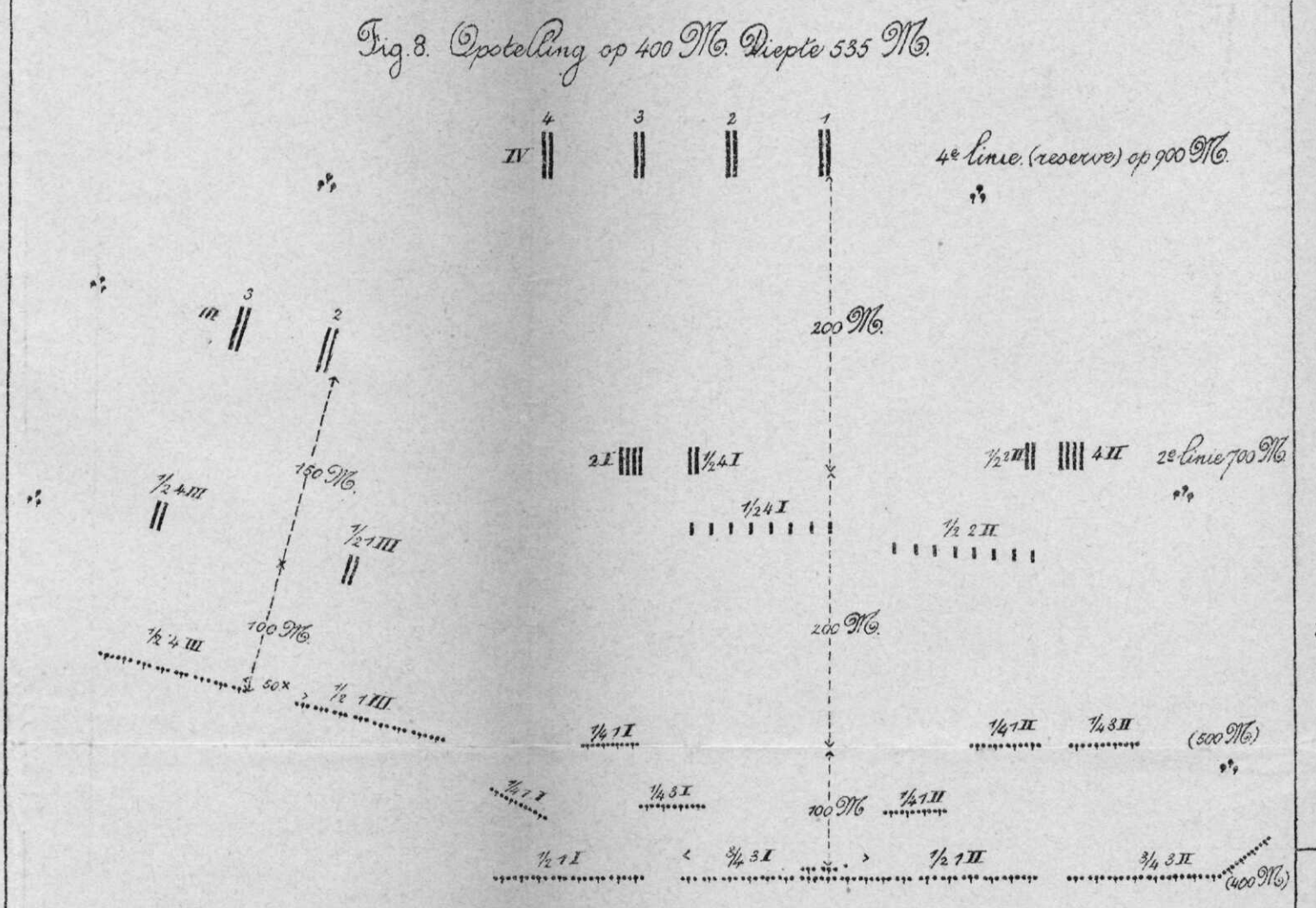
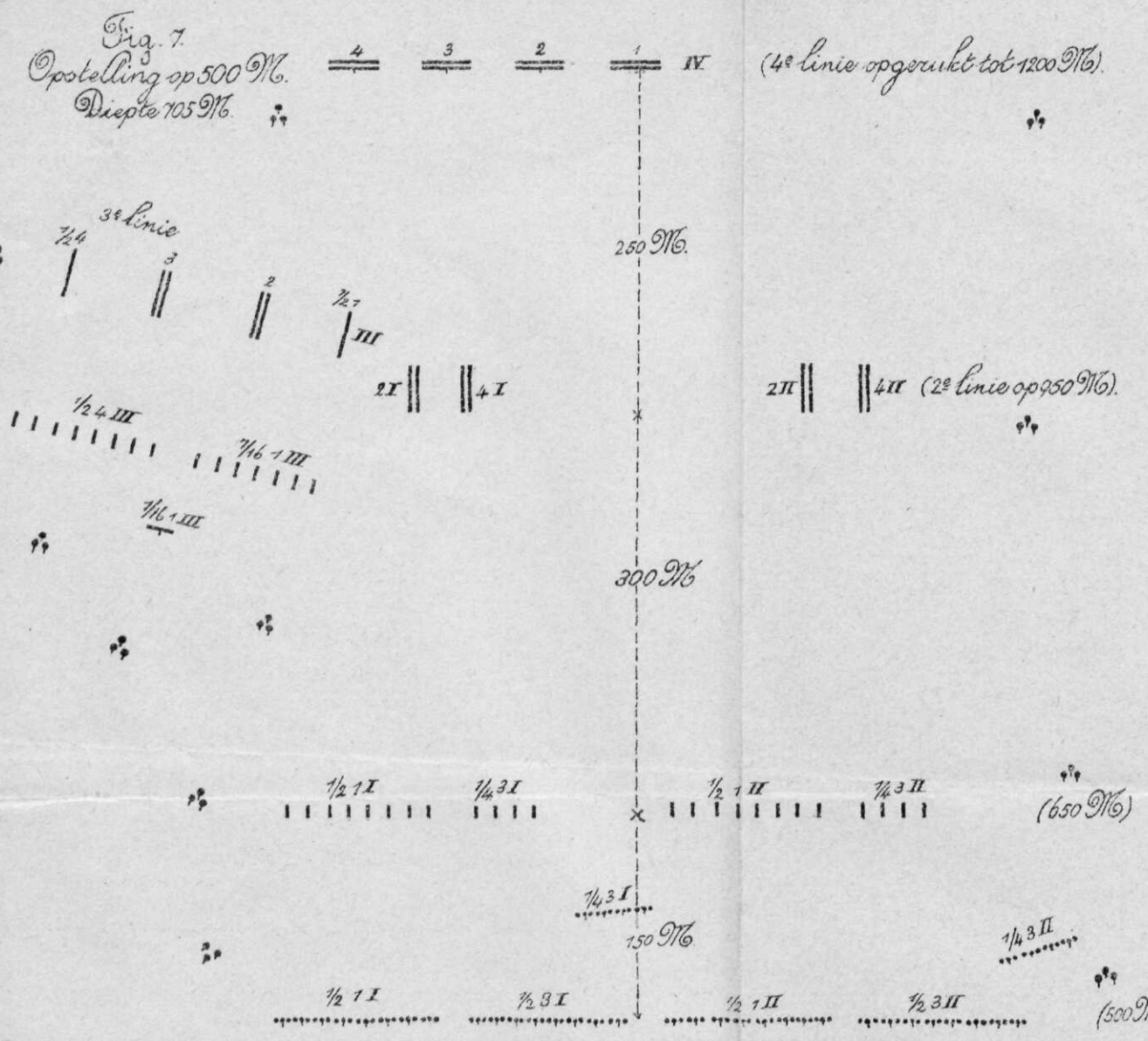

Fig: 1.

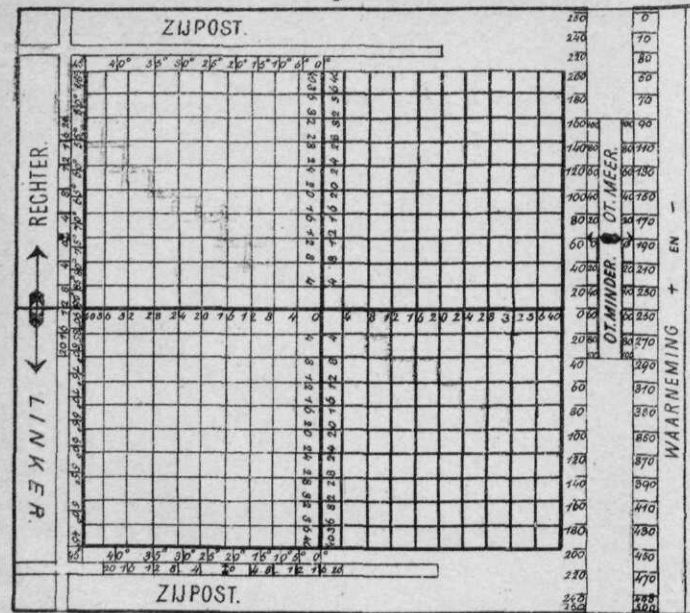

Fig: 2.

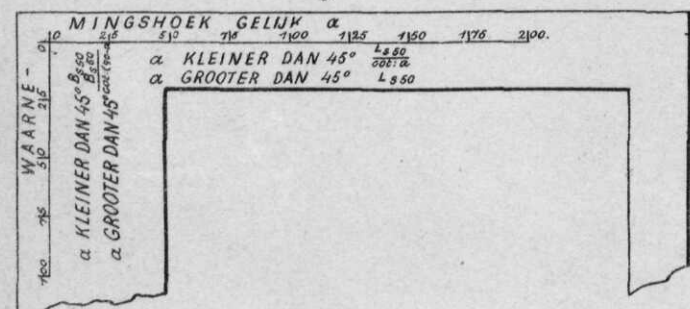

Fig: 3.

Fig: 3^a.

Fig: 3^b.

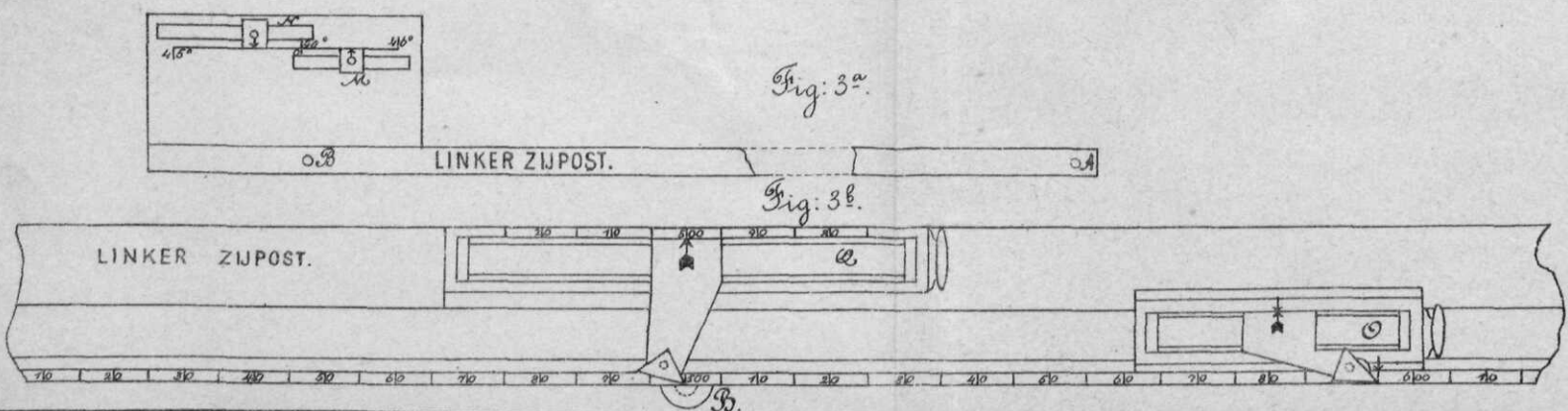

Fig: 5.

Fig: 5^e.

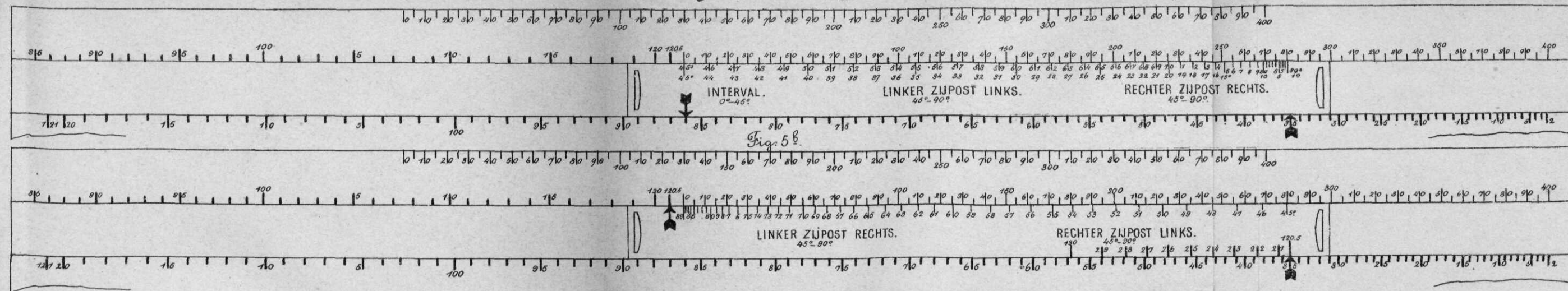

Fig: 5^e.

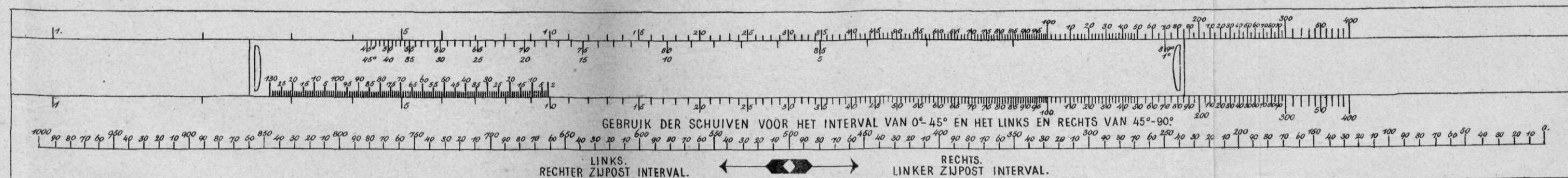

Fig: 4.

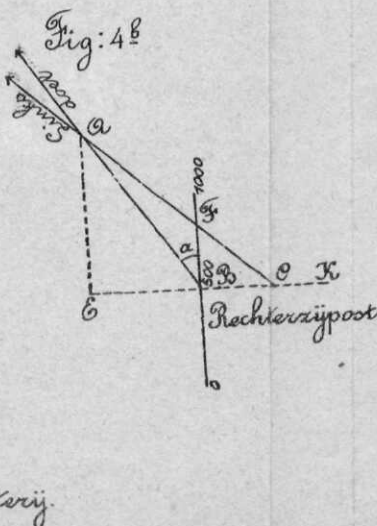
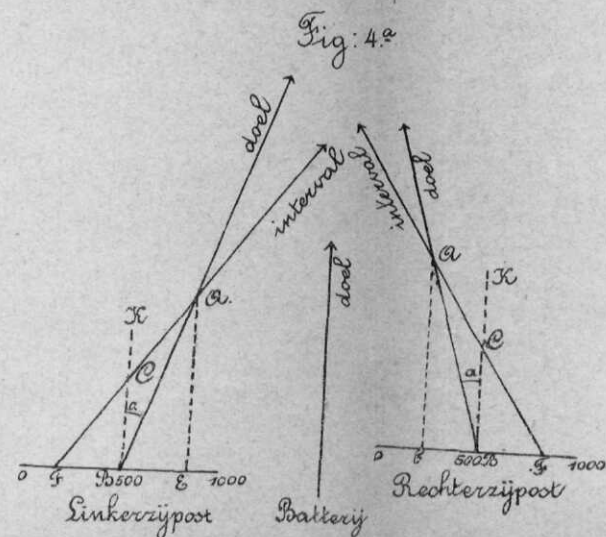

Fig: 6.

Fig: 6^a.

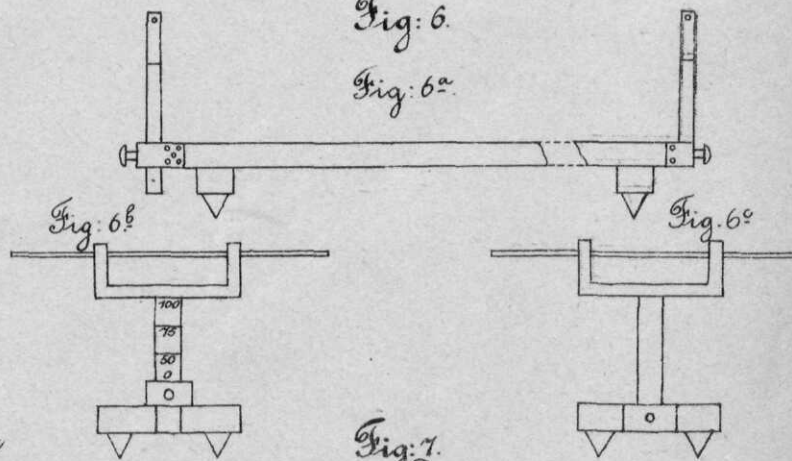

Fig: 7.

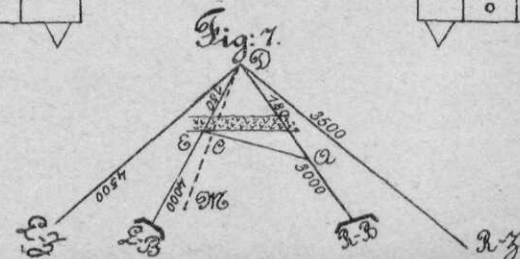
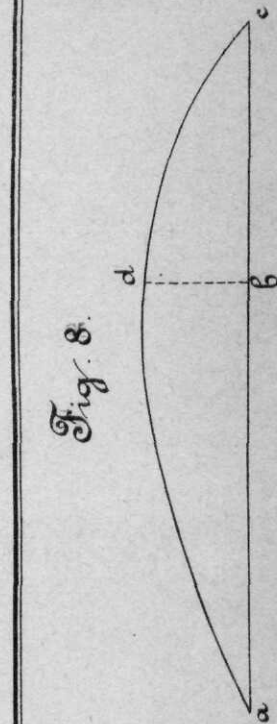

Fig: 8.



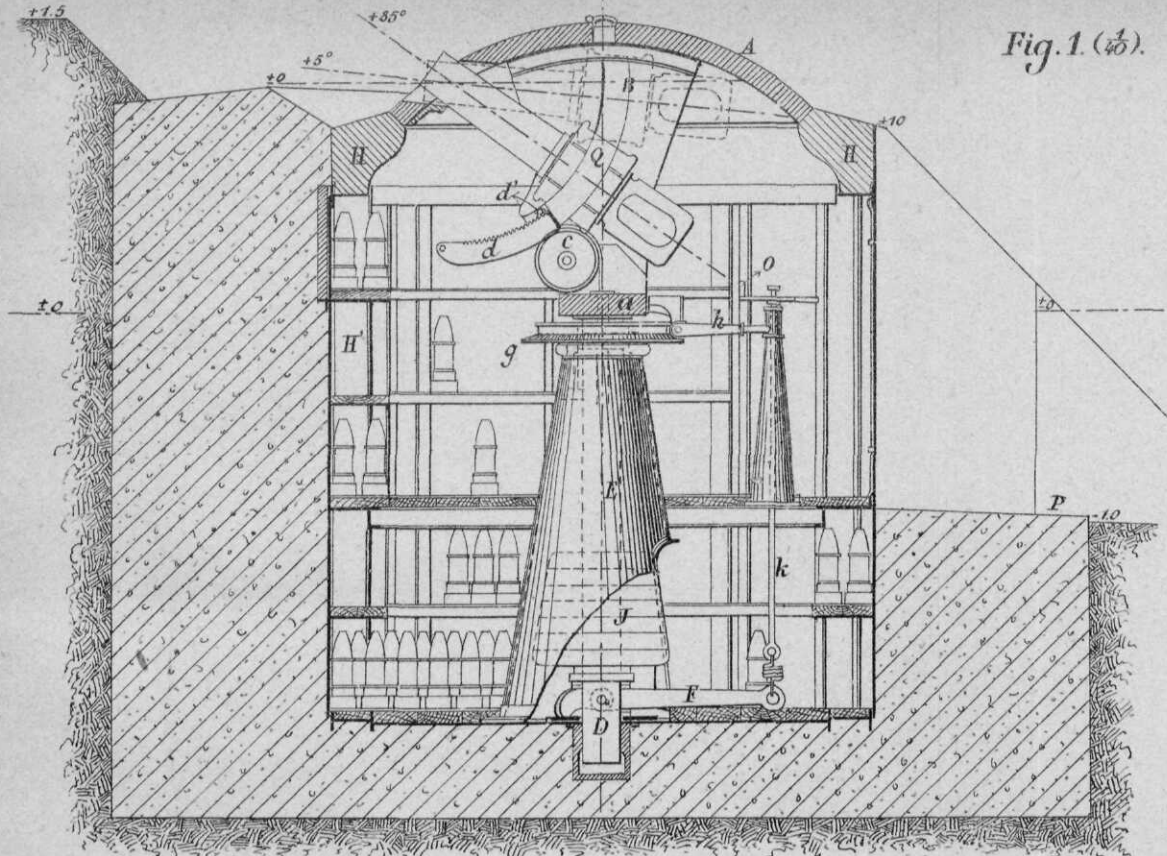
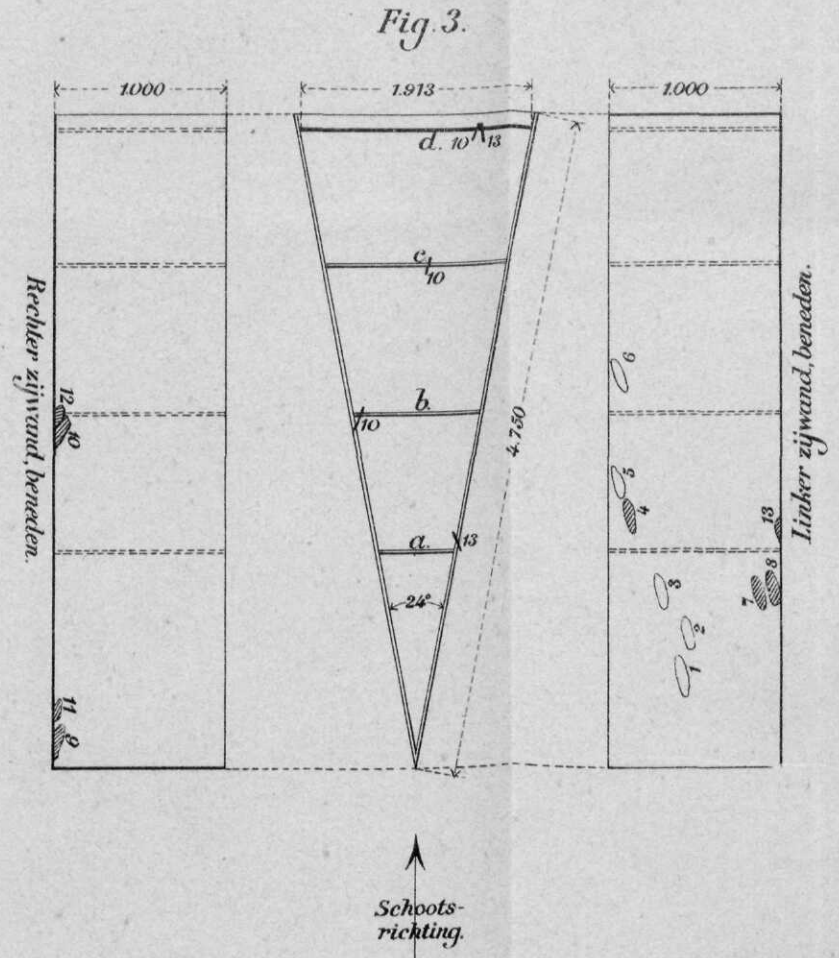
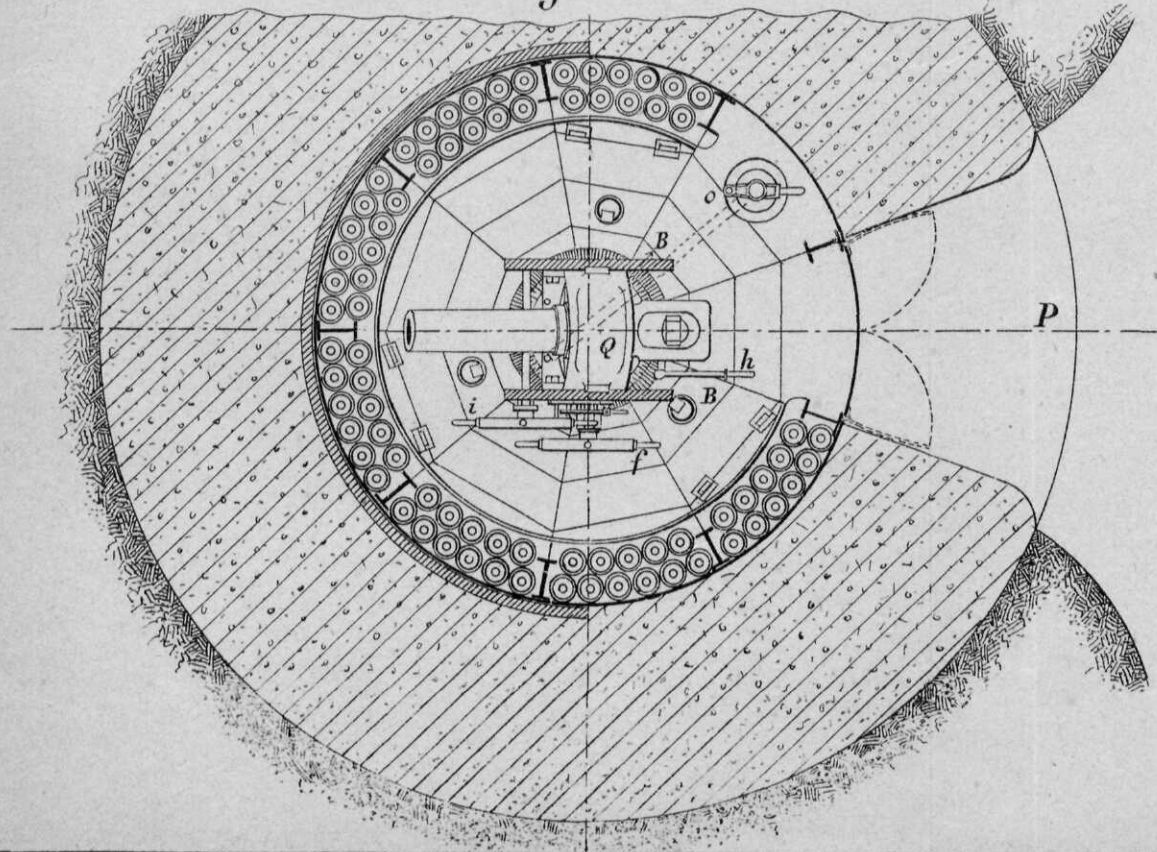

Fig. 1. (1/2).

Fig. 2. (1/2).



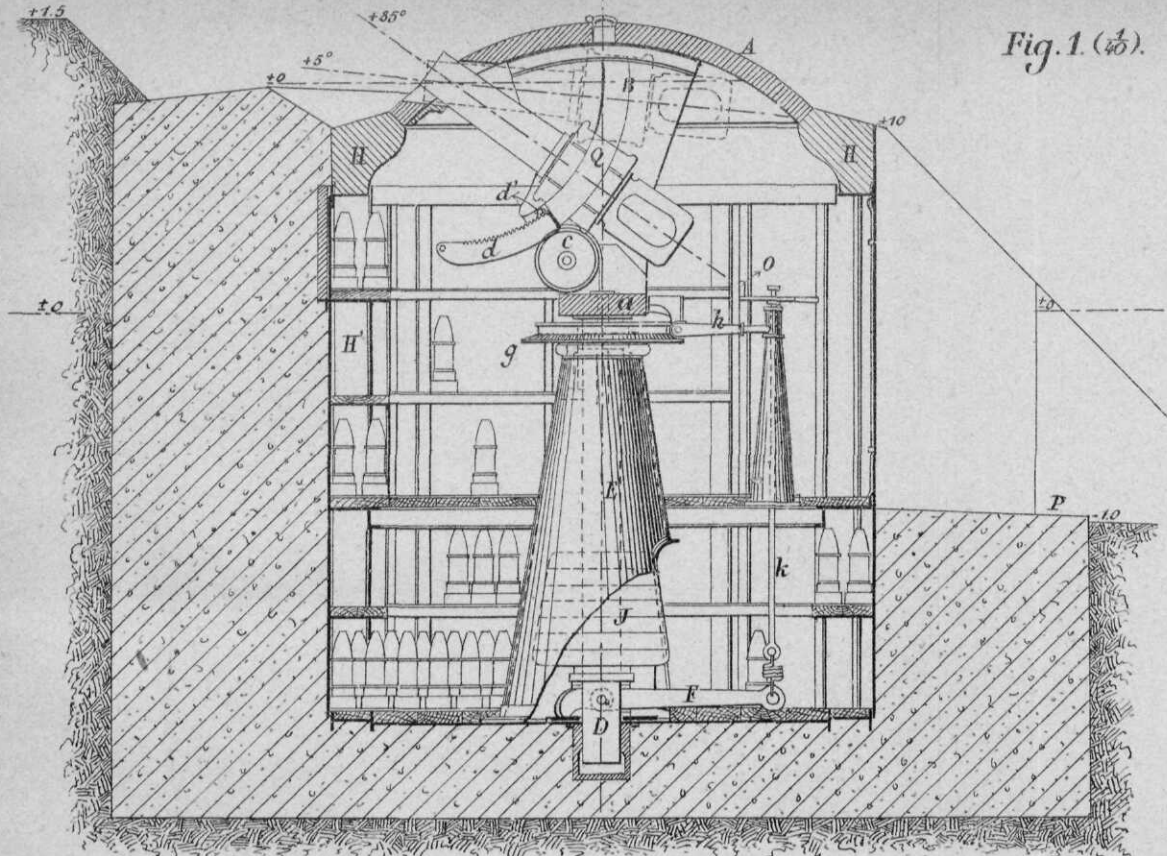
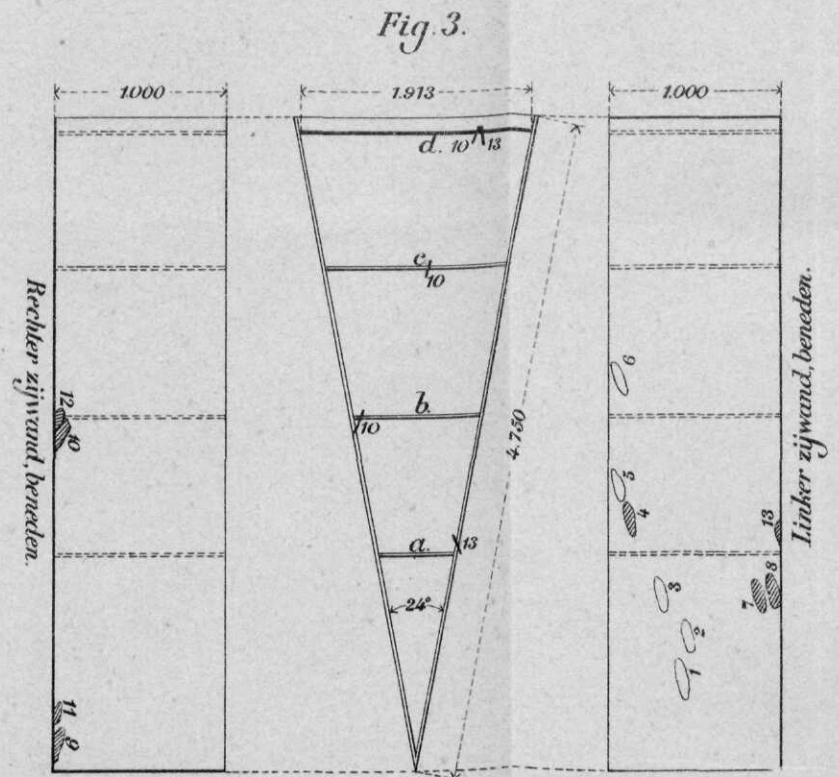
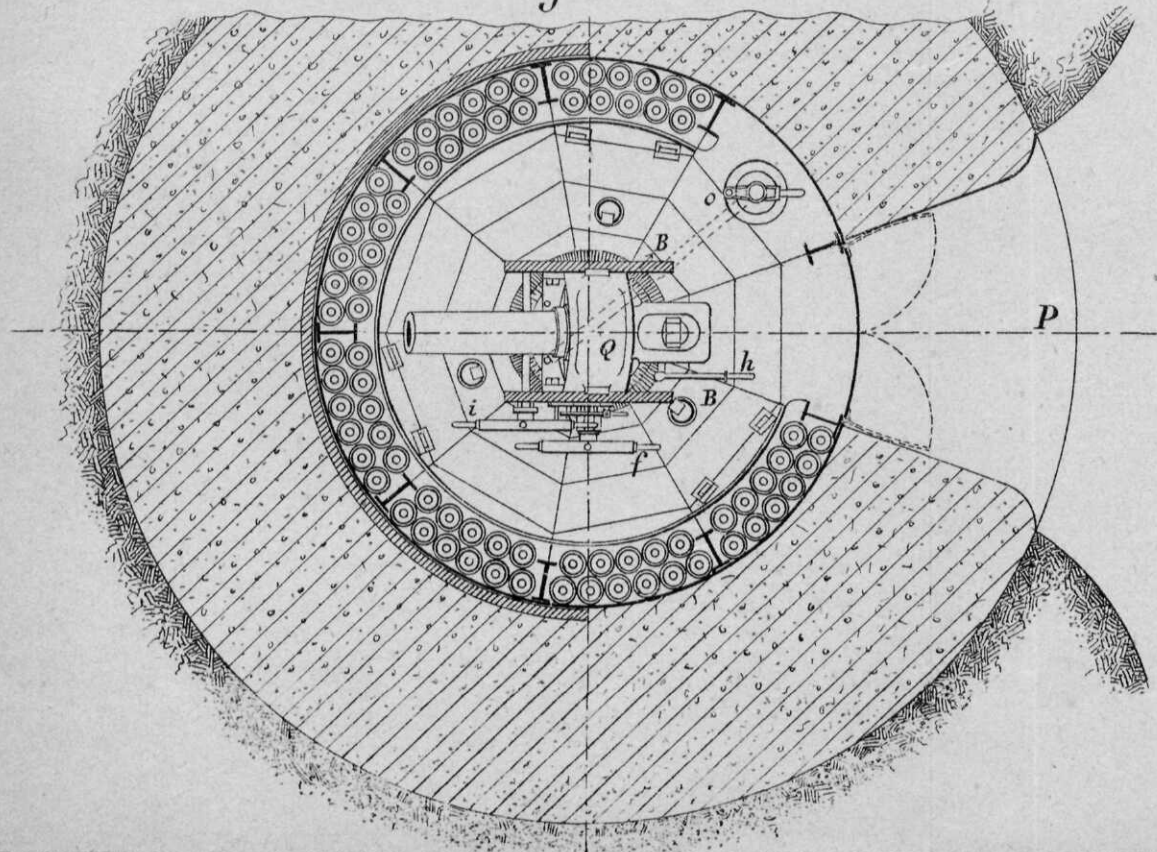

Fig. 1. (1/2).

Fig. 2. (1/2).



Schoots-
richting.