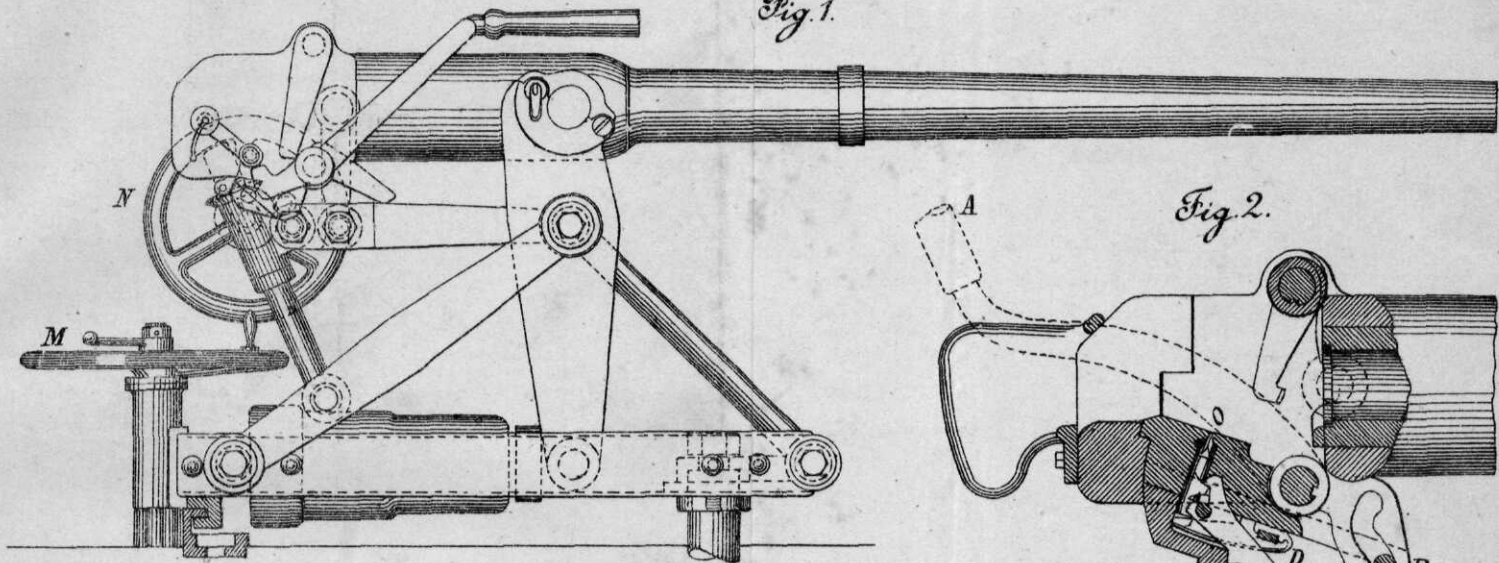
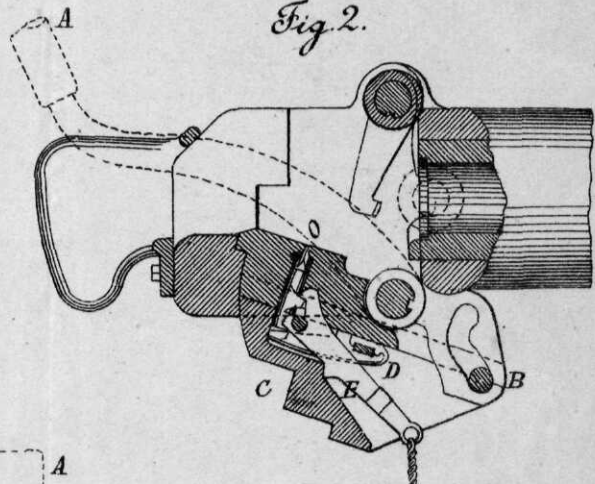

*Fig. 1.*



*Fig. 2.*



*Fig. 3.*

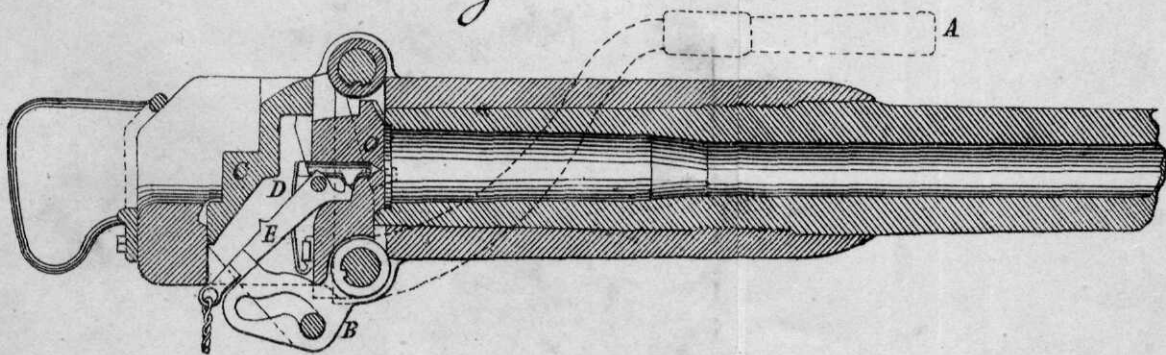

# DE WHITEHEAD-TORPEDO. Fig. 1.

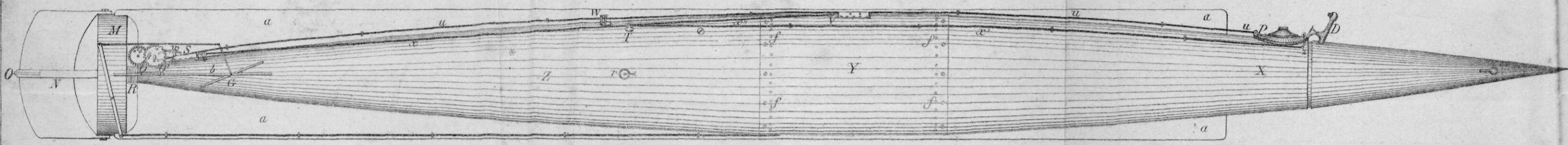

Fig. 2.

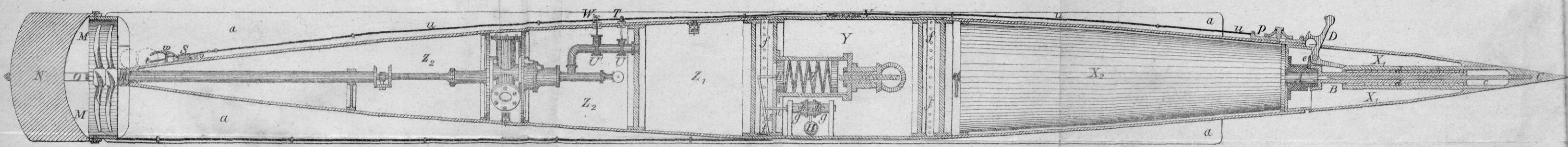

Fig. 4.

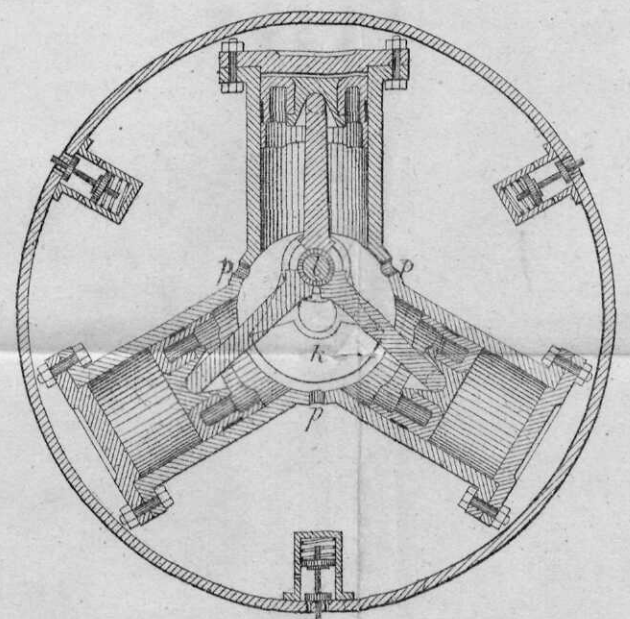
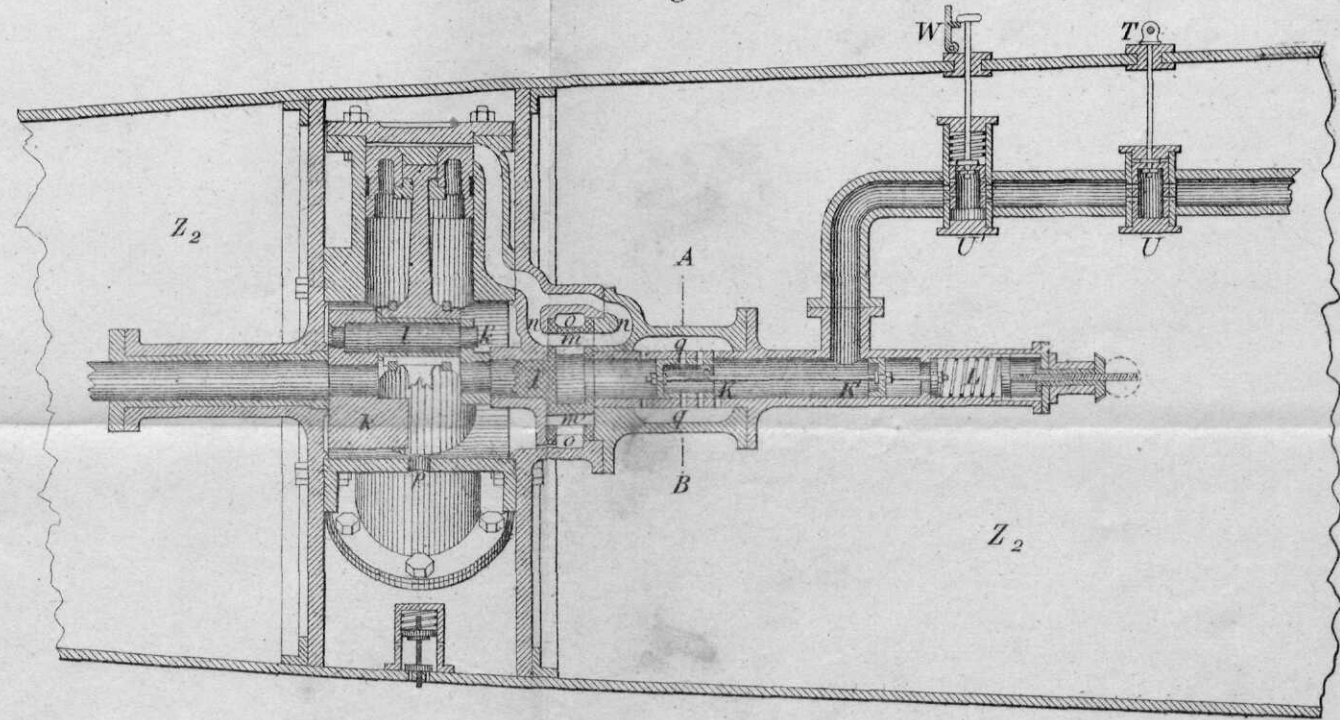

Fig. 5.  
Doorsnede over AB  
van fig. 3.



Fig. 3.



# Schietsproef te Spezia, 20-29 April 1886.

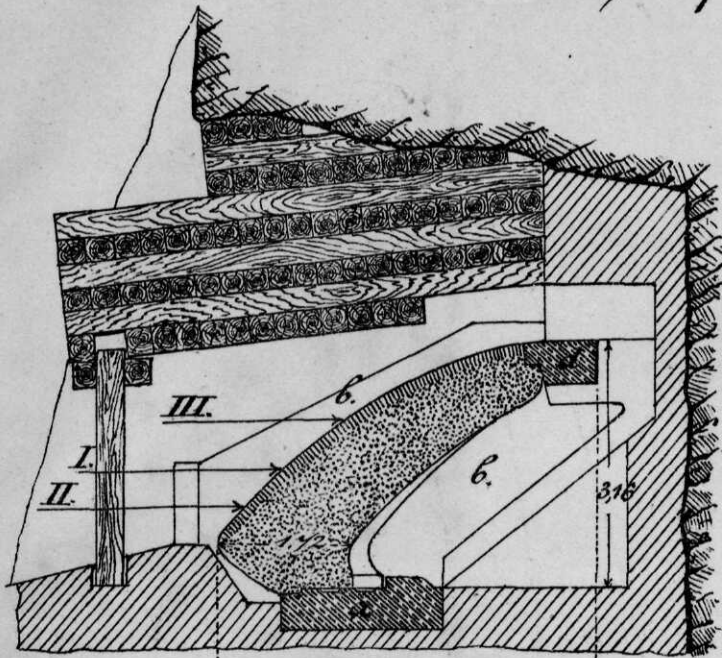

Fig. 1. Opstelling. (100).

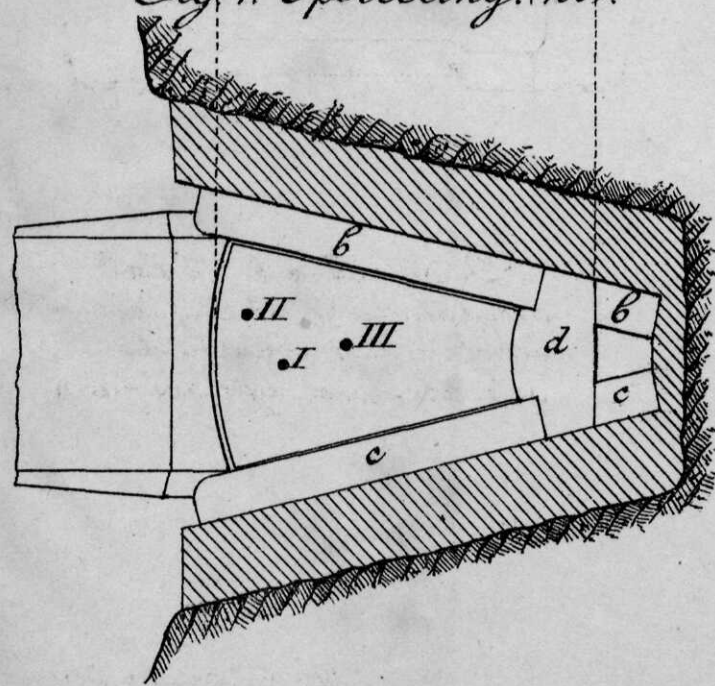
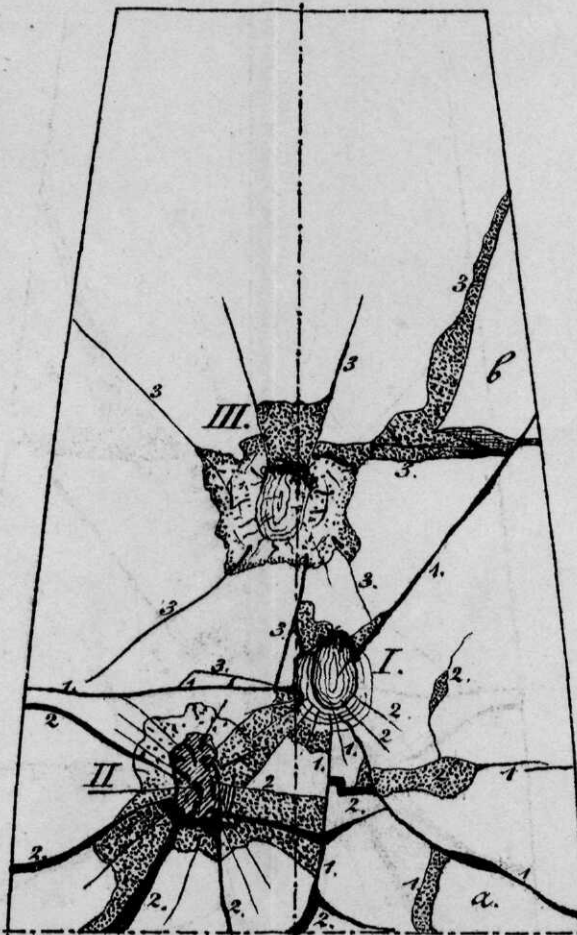
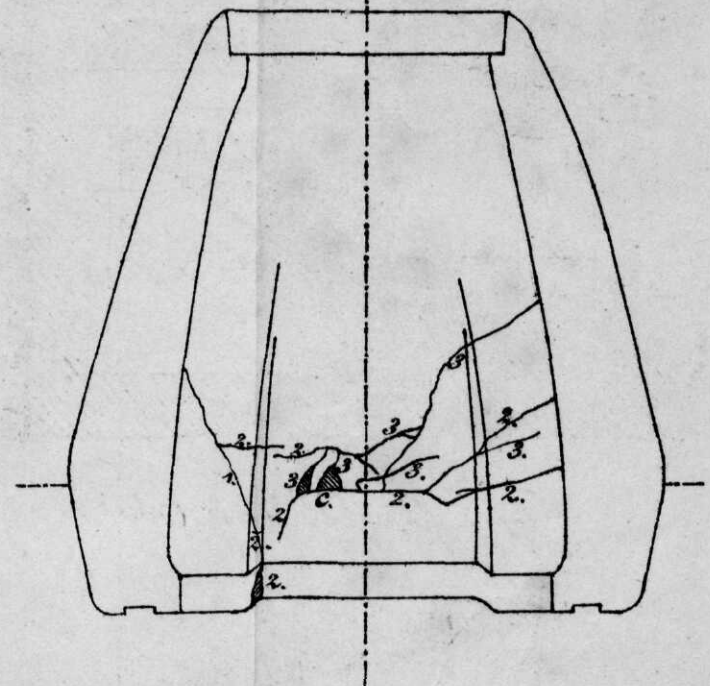

Fig. 2. Ontwikkeld.  
buitenoppervlak. (40).



Bovenrand voorpantser.

Fig. 3.  
Binnenzijde. (40).



De cijfers in fig. 2 en 3  
duiden de nummers der  
schoten aan, waarbij de  
scheuren, enz. zijn ontstaan.

Pantserkoepels voor landbevestiging van Schumann.

Fig. 1.  
Pantsering voor zware kanonnen en howitzers.

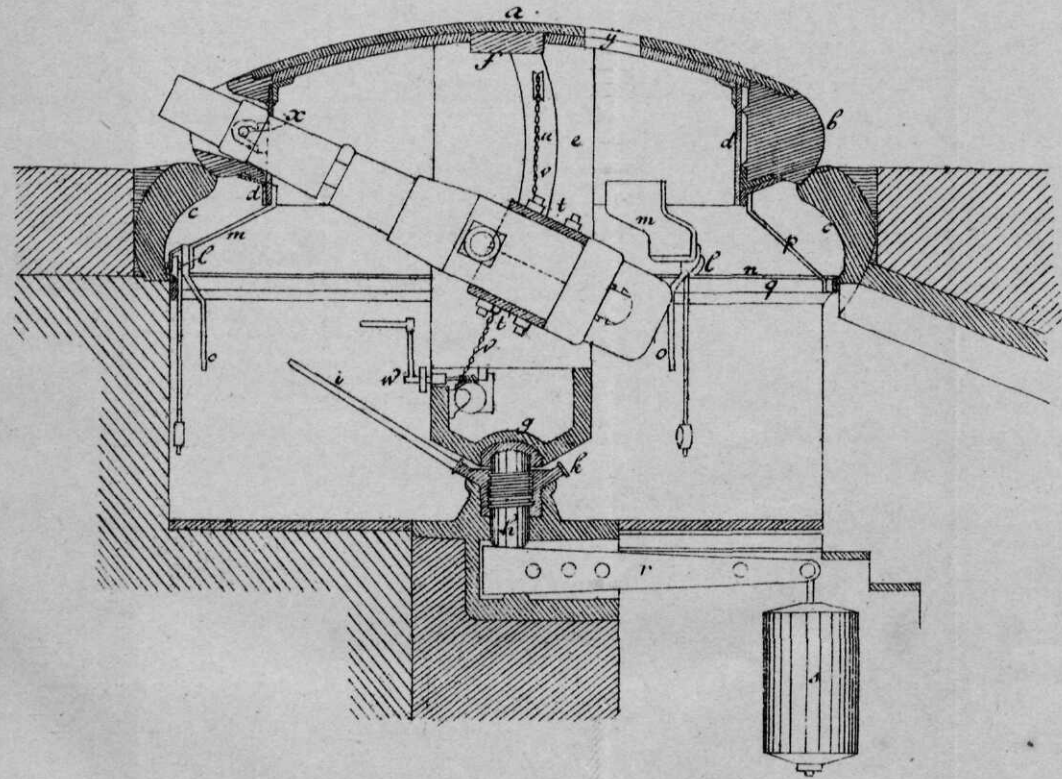
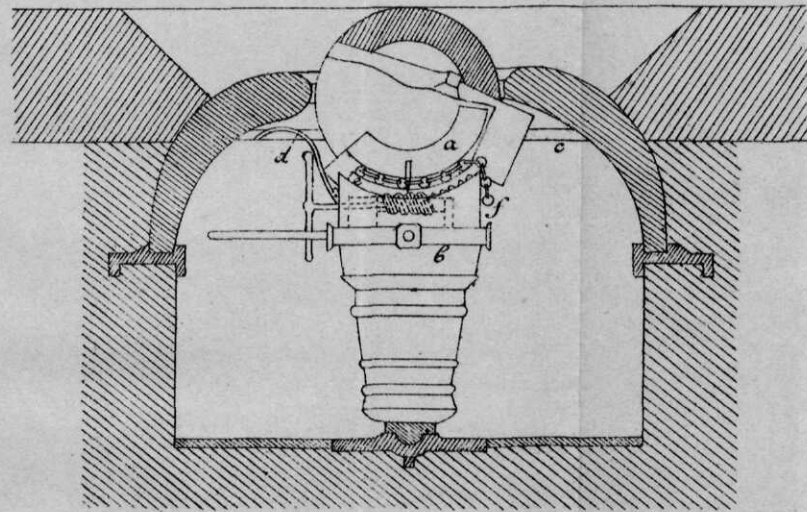
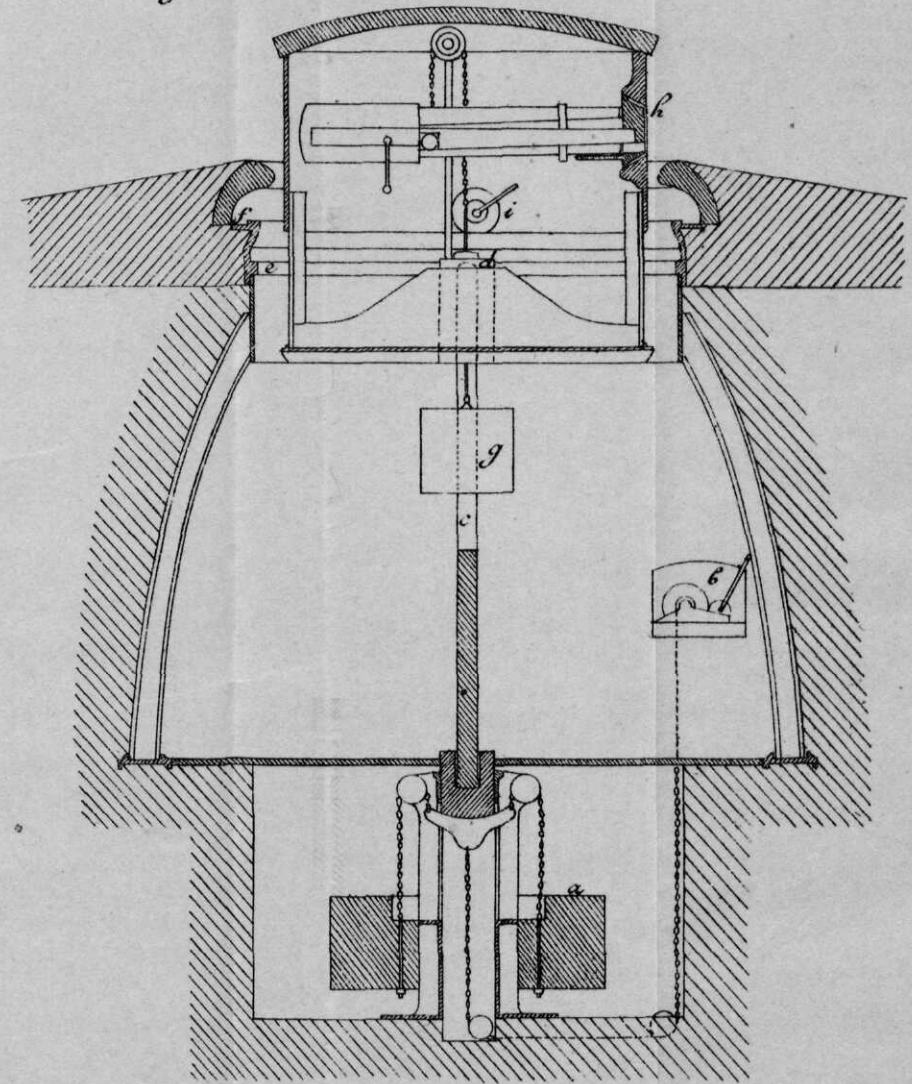

Fig. 2.  
Pantsering voor mortieren van 21 c. M.



Schaal 1 à 50.

Fig. 3.  
Pantsering voor revolverkanonnen van 53 m M.



# Kringloop Versterkingokunst.

Fig. 1. (1/25000) Figuratieve voorstelling van een gedeelte onzer liniën.

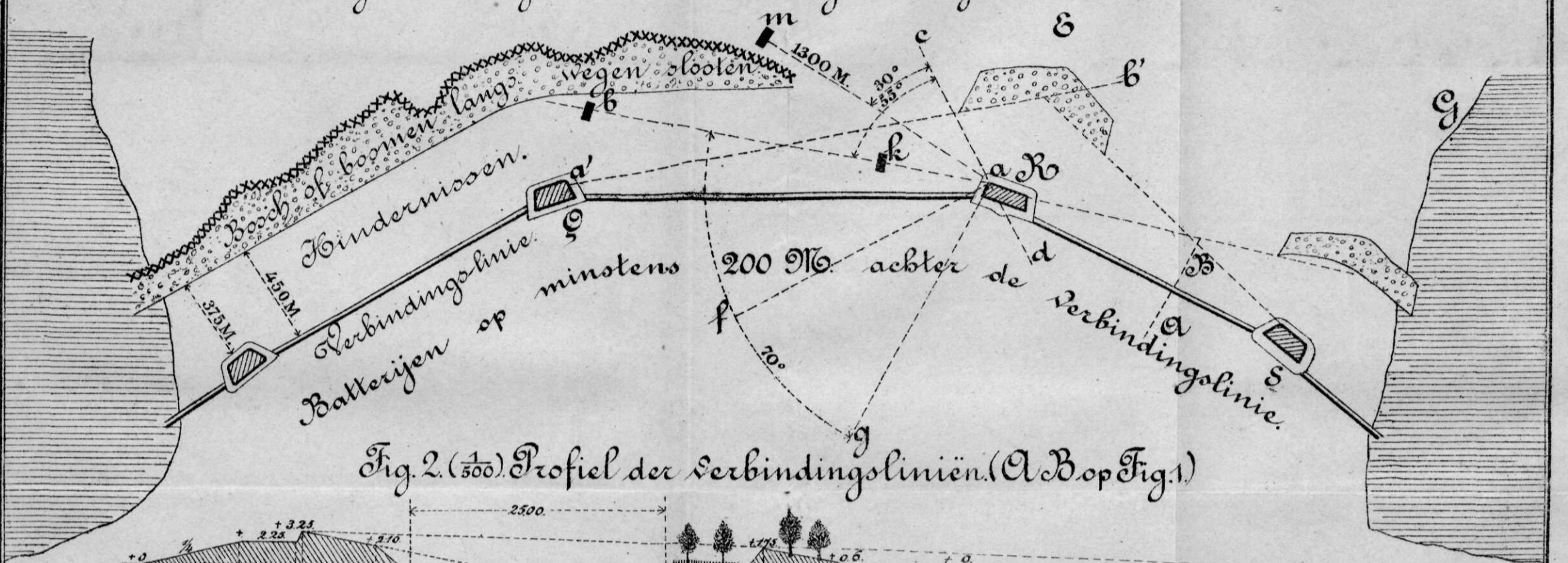

Fig. 2. (1/500) Profiel der verbindingsliniën (A B op Fig. 1)

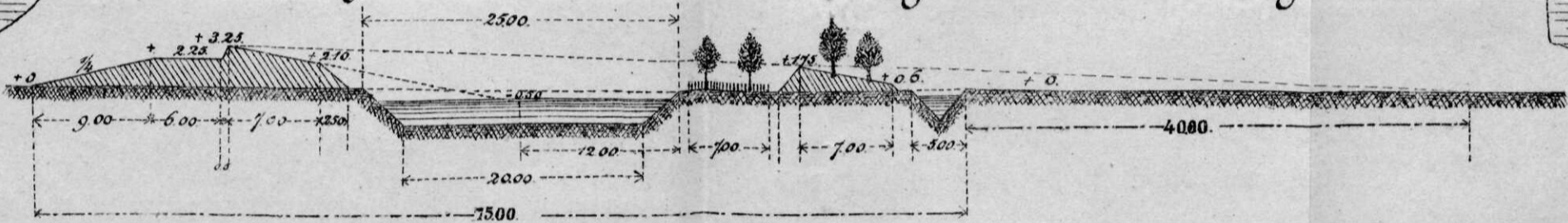

Fig. 3. (1/500) Profiel over een bestaanden boogen fortwal met glacis.

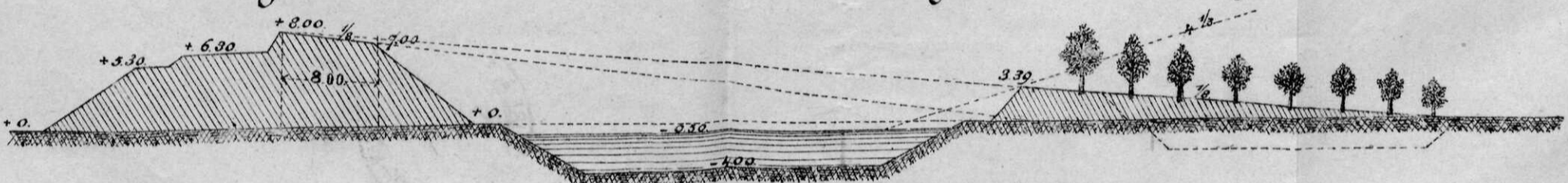

Fig. 4. (1/500) Gewijzigd profiel Fig. 3.



Fig. 5. (1/500) Profiel van een bestaanden fortwal van middelbare boogte zonder glacis.

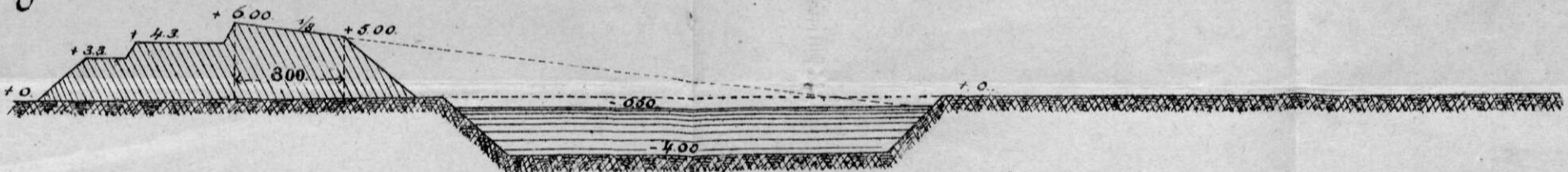

Fig. 6. (1/500) Gewijzigd profiel Fig. 5.



Fig. 1.



## Loopenspion.

Fig. 2.



Fig. 4. (1:1).

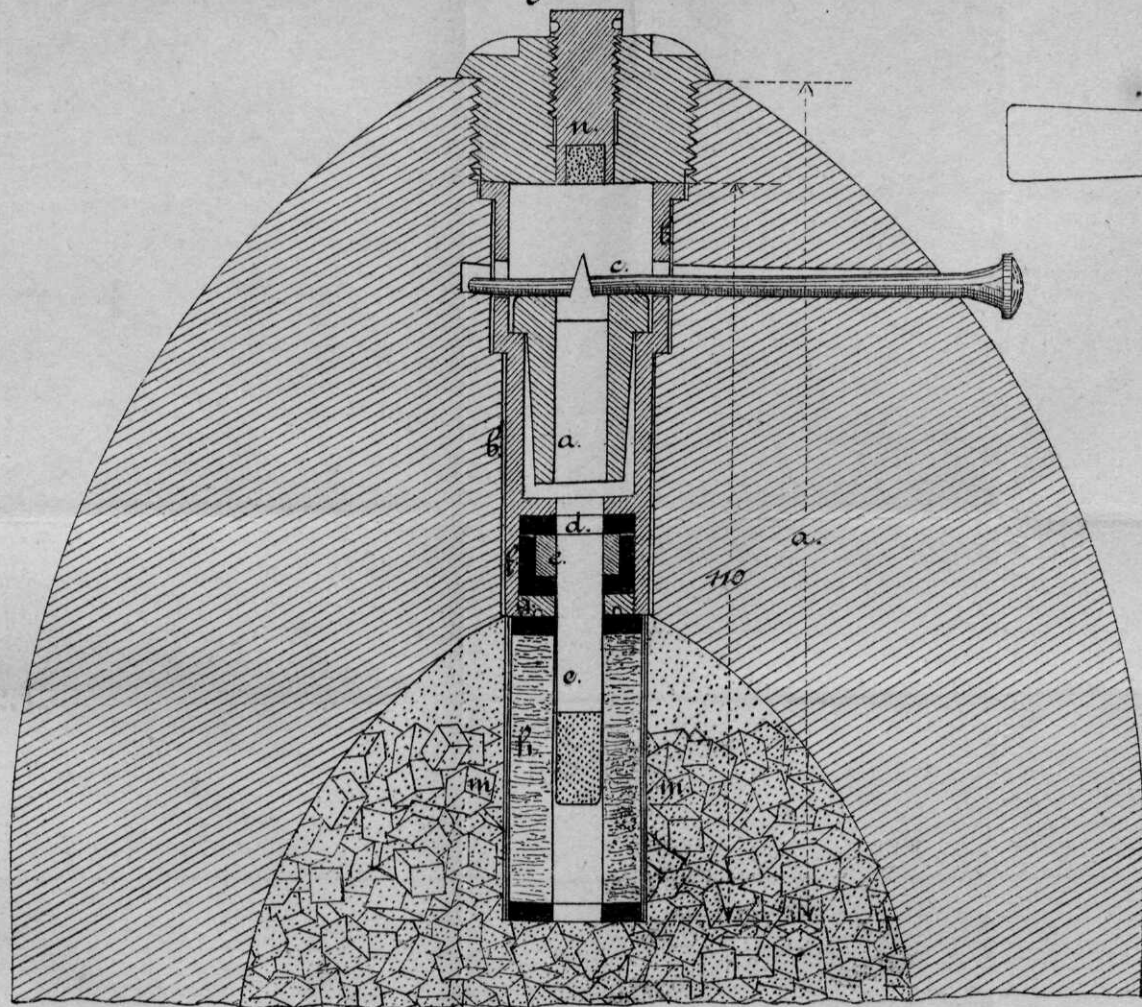

Fig. 10. (1:1).

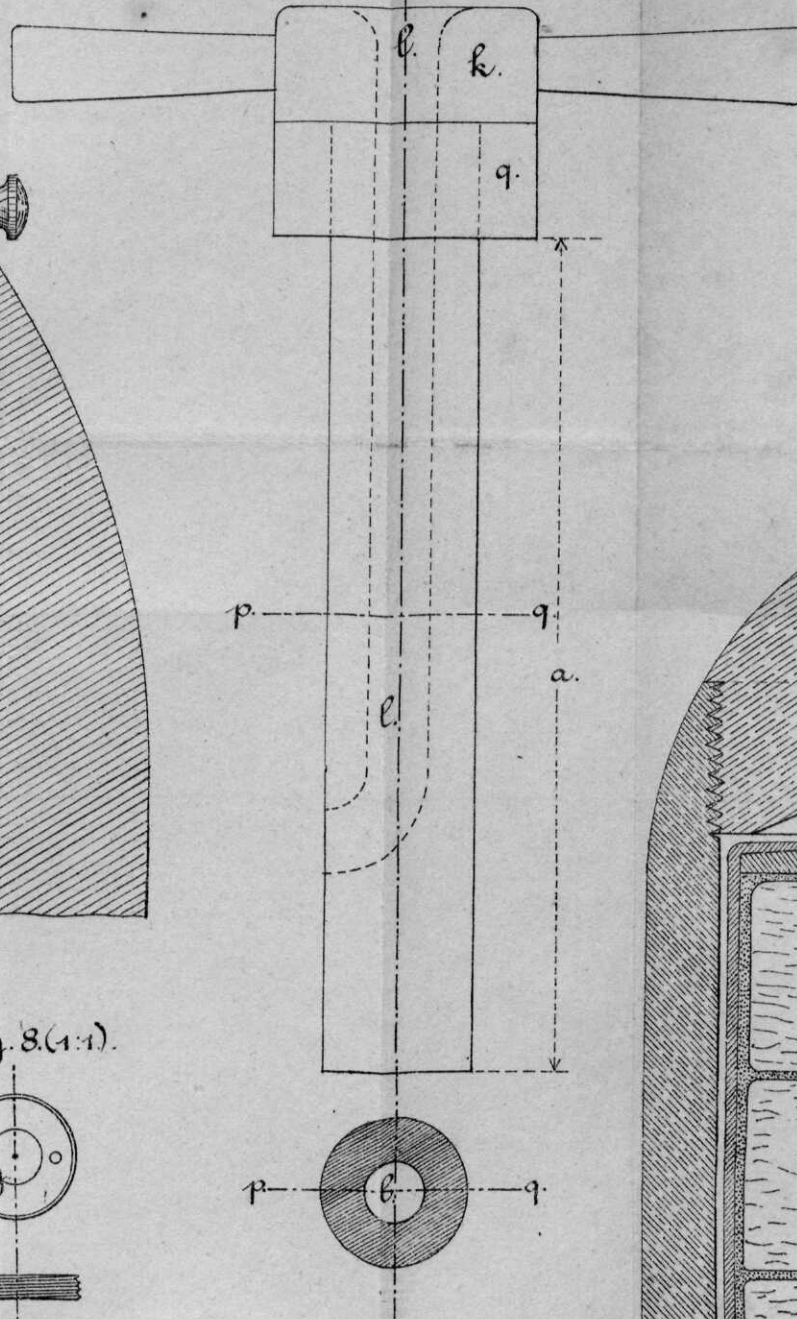

Fig. 13. (1:2).

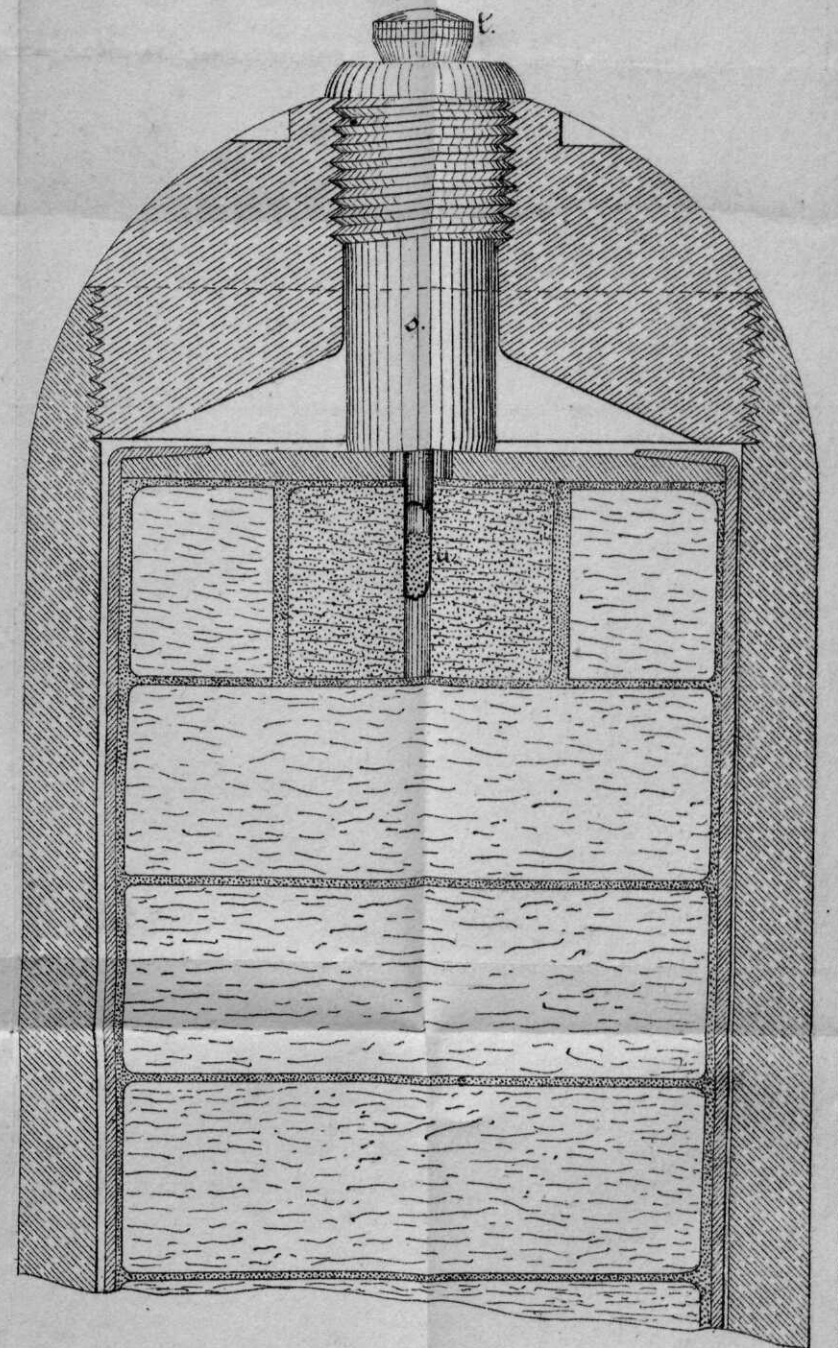

Fig. 3.

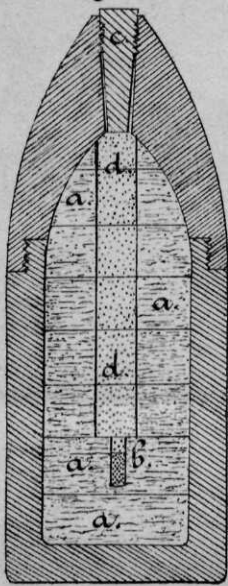

Fig. 1. (1:1).



Fig. 2. (1:1).

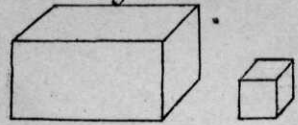

Fig. 5. (1:1).

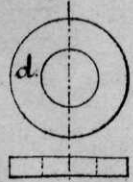

Fig. 6. (1:1).

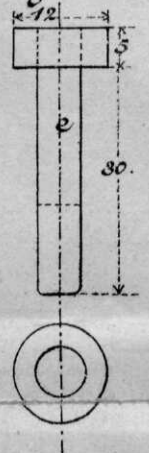

Fig. 9. (1:1).

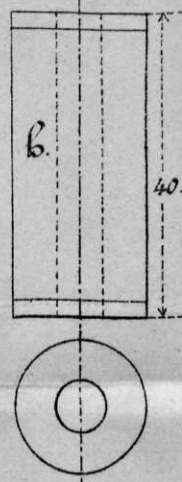

Fig. 11. (1:1).

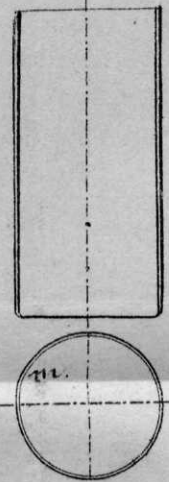

Fig. 8. (1:1).

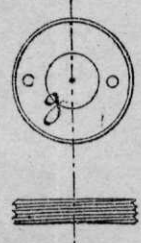
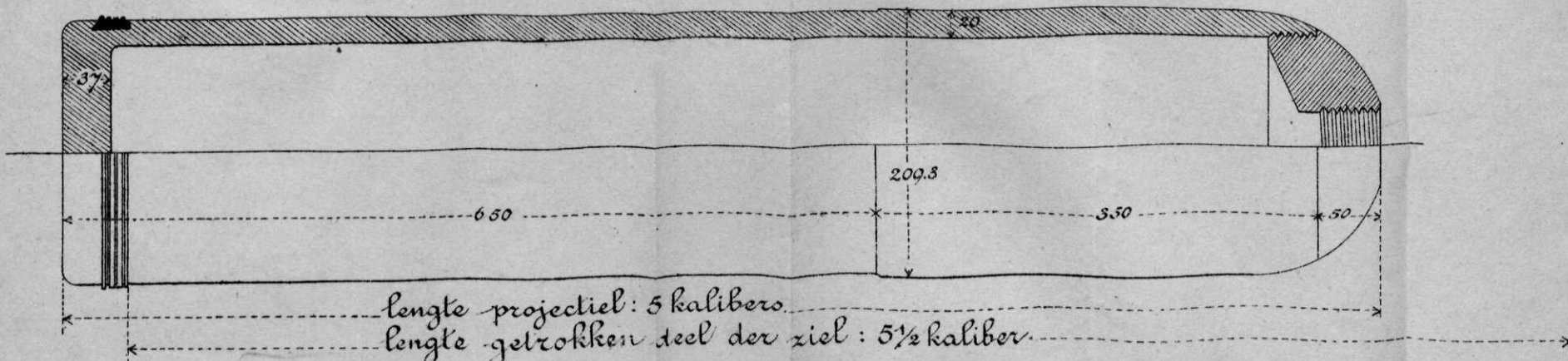

Fig. 7. (1:1).



Fig. 12. (1:5).



1886

# Schetskaart der Fransch-Belgische grens. 1:500000.

Milit. Spectator 4<sup>de</sup> Serie 11<sup>de</sup> Deel. N<sup>o</sup> 5.

Plaat II.

